



JAY® J3 Posterior (PA) Backrest

E2613 (Under 22" Wide)

January 2025

Mark For: _____
 Date: _____
 Dealer Acct #: _____
 Dealer: _____
 Dealer Contact: _____
 Dealer Address: _____
 Dealer City: _____ ST: _____ ZIP: _____
 Dealer Phone: () _____ Fax: () _____
 Confirmation Email: _____
 Confirm Via: Fax Email

Submitting for: Quote Order
 PO#: _____
ADDITIONAL SHIPPING INFORMATION
 Ship To: _____
 Attention: _____
 Address: _____
 Address: _____
 Ship To City: _____ ST: _____ ZIP: _____
 Ship To Phone: () _____ Fax () _____

The **HCPCS CODES** herein are based on PDAC verification or interpretation of Medicare definitions and guidelines. Non-Medicare payers may accept alternative **HCPCS CODES**, including misc. codes to ensure access for their enrollees. The use of **HCPCS CODES** does not ensure coverage or payment.

JAY J3 Posterior (PA) Back - E2613



BACKREST WIDTH	12"	14"	16"	18"	20"
BACKCANE WIDTHS	12"- 14"	14"- 16"	16"- 18"	18"- 20"	20"- 22"
MAX. USER TRUNK WIDTH	11"	13"	15"	17"	19"

Back Height	Lower Thoracic (LT)																	
		6.5" (S)	J3PALTSxxSH	<input type="checkbox"/>	14	\$625	<input type="checkbox"/>	16	\$625	<input type="checkbox"/>	18	\$625						
			J3PALTSxxRH	<input type="checkbox"/>	14	\$625	<input type="checkbox"/>	16	\$625	<input type="checkbox"/>	18	\$625						
			J3PALTSxxRHF	<input type="checkbox"/>	14	\$625	<input type="checkbox"/>	16	\$625	<input type="checkbox"/>	18	\$625						
		8.0" (M)	J3PALTMxxSH	<input type="checkbox"/>	12	\$625	<input type="checkbox"/>	14	\$625	<input type="checkbox"/>	16	\$625	<input type="checkbox"/>	18	\$625			
			J3PALTMxxRH	<input type="checkbox"/>	12	\$625	<input type="checkbox"/>	14	\$625	<input type="checkbox"/>	16	\$625	<input type="checkbox"/>	18	\$625			
			J3PALTMxxRHF	<input type="checkbox"/>	12	\$625	<input type="checkbox"/>	14	\$625	<input type="checkbox"/>	16	\$625	<input type="checkbox"/>	18	\$625			
		9.5" (T)	J3PALTTxxSH	<input type="checkbox"/>	12	\$625	<input type="checkbox"/>	14	\$625	<input type="checkbox"/>	16	\$625	<input type="checkbox"/>	18	\$625	<input type="checkbox"/>	20	\$625
			J3PALTTxxRH	<input type="checkbox"/>	12	\$625	<input type="checkbox"/>	14	\$625	<input type="checkbox"/>	16	\$625	<input type="checkbox"/>	18	\$625	<input type="checkbox"/>	20	\$625
			J3PALTTxxRHF	<input type="checkbox"/>	12	\$625	<input type="checkbox"/>	14	\$625	<input type="checkbox"/>	16	\$625	<input type="checkbox"/>	18	\$625	<input type="checkbox"/>	20	\$625
	Mid Thoracic (MT)																	
		12.0" (S)	J3PAMTSxxSH	<input type="checkbox"/>	12	\$625	<input type="checkbox"/>	14	\$625	<input type="checkbox"/>	16	\$625	<input type="checkbox"/>	18	\$625	<input type="checkbox"/>	20	\$625
J3PAMTSxxFS			<input type="checkbox"/>	12	\$677	<input type="checkbox"/>	14	\$677	<input type="checkbox"/>	16	\$677	<input type="checkbox"/>	18	\$677	<input type="checkbox"/>	20	\$677	
J3PAMTSxxTH			<input type="checkbox"/>	12	\$677	<input type="checkbox"/>	14	\$677	<input type="checkbox"/>	16	\$677	<input type="checkbox"/>	18	\$677	<input type="checkbox"/>	20	\$677	
13.5" (M)		J3PAMTMxxSH	<input type="checkbox"/>	12	\$625	<input type="checkbox"/>	14	\$625	<input type="checkbox"/>	16	\$625	<input type="checkbox"/>	18	\$625	<input type="checkbox"/>	20	\$625	
		J3PAMTMxxFS	<input type="checkbox"/>	12	\$677	<input type="checkbox"/>	14	\$677	<input type="checkbox"/>	16	\$677	<input type="checkbox"/>	18	\$677	<input type="checkbox"/>	20	\$677	
		J3PAMTMxxTH	<input type="checkbox"/>	12	\$677	<input type="checkbox"/>	14	\$677	<input type="checkbox"/>	16	\$677	<input type="checkbox"/>	18	\$677	<input type="checkbox"/>	20	\$677	
15.0" (T)	J3PAMTTxxSH	<input type="checkbox"/>	12	\$625	<input type="checkbox"/>	14	\$625	<input type="checkbox"/>	16	\$625	<input type="checkbox"/>	18	\$625	<input type="checkbox"/>	20	\$625		
	J3PAMTTxxFS	<input type="checkbox"/>	12	\$677	<input type="checkbox"/>	14	\$677	<input type="checkbox"/>	16	\$677	<input type="checkbox"/>	18	\$677	<input type="checkbox"/>	20	\$677		
Upper Thoracic (UT)																		
	16.5" (S)	J3PAUTSxxSH	<input type="checkbox"/>	12	\$625	<input type="checkbox"/>	14	\$625	<input type="checkbox"/>	16	\$625	<input type="checkbox"/>	18	\$625	<input type="checkbox"/>	20	\$625	
		J3PAUTSxxFS	<input type="checkbox"/>	12	\$677	<input type="checkbox"/>	14	\$677	<input type="checkbox"/>	16	\$677	<input type="checkbox"/>	18	\$677	<input type="checkbox"/>	20	\$677	
		J3PAUTSxxTH	<input type="checkbox"/>	12	\$677	<input type="checkbox"/>	14	\$677	<input type="checkbox"/>	16	\$677	<input type="checkbox"/>	18	\$677	<input type="checkbox"/>	20	\$677	
	18.0" (M)	J3PAUTMxxSH	<input type="checkbox"/>	14	\$625	<input type="checkbox"/>	16	\$625	<input type="checkbox"/>	18	\$625	<input type="checkbox"/>	20	\$625				
		J3PAUTMxxFS	<input type="checkbox"/>	14	\$677	<input type="checkbox"/>	16	\$677	<input type="checkbox"/>	18	\$677	<input type="checkbox"/>	20	\$677				
		J3PAUTMxxTH	<input type="checkbox"/>	14	\$677	<input type="checkbox"/>	16	\$677	<input type="checkbox"/>	18	\$677	<input type="checkbox"/>	20	\$677				
19.5" (T)	J3PAUTTxxSH	<input type="checkbox"/>	14	\$625	<input type="checkbox"/>	16	\$625	<input type="checkbox"/>	18	\$625	<input type="checkbox"/>	20	\$625					
	J3PAUTTxxFS	<input type="checkbox"/>	14	\$677	<input type="checkbox"/>	16	\$677	<input type="checkbox"/>	18	\$677	<input type="checkbox"/>	20	\$677					
Shoulder Height (SH)																		
	21.0" (S)	J3PASHSxxSH	<input type="checkbox"/>	14	\$625	<input type="checkbox"/>	16	\$625	<input type="checkbox"/>	18	\$625	<input type="checkbox"/>	20	\$625				
		J3PASHSxxFS	<input type="checkbox"/>	14	\$677	<input type="checkbox"/>	16	\$677	<input type="checkbox"/>	18	\$677	<input type="checkbox"/>	20	\$677				
		J3PASHSxxTH	<input type="checkbox"/>	14	\$677	<input type="checkbox"/>	16	\$677	<input type="checkbox"/>	18	\$677	<input type="checkbox"/>	20	\$677				
	22.5" (M)	J3PASHMxxSH	<input type="checkbox"/>	16	\$625	<input type="checkbox"/>	18	\$625	<input type="checkbox"/>	20	\$625							
		J3PASHMxxFS	<input type="checkbox"/>	16	\$677	<input type="checkbox"/>	18	\$677	<input type="checkbox"/>	20	\$677							
	24.0" (T)	J3PASHTxxSH	<input type="checkbox"/>	18	\$625	<input type="checkbox"/>	20	\$625										
J3PASHTxxFS		<input type="checkbox"/>	18	\$677	<input type="checkbox"/>	20	\$677											
		J3PASHTxxTH	<input type="checkbox"/>	18	\$677	<input type="checkbox"/>	20	\$677										

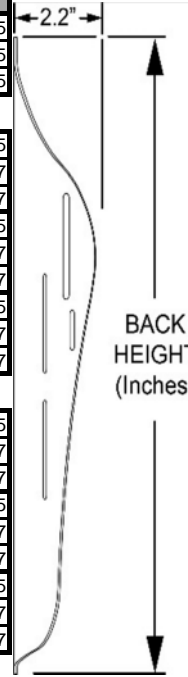

MOUNTING HARDWARE OPTIONS

SH

RH

RHF

TH

FS

Note: Hardware choices are not offered on every size of J3 Backrest, only options listed above are available.

Note: For 22"-26" Wide J3 backs please see the J3 Plus Backrest Order Form on www.SunriseMedical.com



JAY® J3 Posterior Lateral (PL) Backrest

E2615

January 2025

Mark For: _____
 Date: _____
 Dealer Acct #: _____
 Dealer: _____
 Dealer Contact: _____
 Dealer Address: _____
 Dealer City: _____ ST: _____ ZIP: _____
 Dealer Phone: () _____ Fax: () _____
 Confirmation Email: _____
 Confirm Via: Fax Email

Submitting for: Quote Order
 PO#: _____
ADDITIONAL SHIPPING INFORMATION
 Ship To: _____
 Attention: _____
 Address: _____
 Address: _____
 Ship To City: _____ ST: _____ ZIP: _____
 Ship To Phone: () _____ Fax () _____

The **HCPCS CODES** herein are based on PDAC verification or interpretation of Medicare definitions and guidelines. Non-Medicare payers may accept alternative **HCPCS CODES**, including misc. codes to ensure access for their enrollees. The use of **HCPCS CODES** does not ensure coverage or payment.

JAY J3 Posterior Lateral (PL) Back - E2615



BACKREST WIDTH	12"	14"	16"	18"	20"
BACKCANE WIDTHS	12"- 14"	14"- 16"	16"- 18"	18"- 20"	20"- 22"
MAX. USER TRUNK WIDTH	9.5"	11.5"	13.5"	15.5"	17.5"

Backrest	Lower Thoracic (LT)		X	Y	Options														
	6.5" (S)	8" (M)			9.5" (T)	12"	14"	16"	18"	20"	12"	14"	16"	18"	20"				
Mid Thoracic (MT)	12.0" (S)	4.5"	5.5"	J3PLMTSxxSH	<input type="checkbox"/>	12	\$729	<input type="checkbox"/>	14	\$729	<input type="checkbox"/>	16	\$729	<input type="checkbox"/>	18	\$729	<input type="checkbox"/>	20	\$729
				J3PLMTSxxFS	<input type="checkbox"/>	12	\$781	<input type="checkbox"/>	14	\$781	<input type="checkbox"/>	16	\$781	<input type="checkbox"/>	18	\$781	<input type="checkbox"/>	20	\$781
				J3PLMTSxxTH	<input type="checkbox"/>	12	\$781	<input type="checkbox"/>	14	\$781	<input type="checkbox"/>	16	\$781	<input type="checkbox"/>	18	\$781	<input type="checkbox"/>	20	\$781
	13.5" (M)	4.5"	7.0"	J3PLMTMxxSH	<input type="checkbox"/>	12	\$729	<input type="checkbox"/>	14	\$729	<input type="checkbox"/>	16	\$729	<input type="checkbox"/>	18	\$729	<input type="checkbox"/>	20	\$729
				J3PLMTMxxFS	<input type="checkbox"/>	12	\$781	<input type="checkbox"/>	14	\$781	<input type="checkbox"/>	16	\$781	<input type="checkbox"/>	18	\$781	<input type="checkbox"/>	20	\$781
				J3PLMTMxxTH	<input type="checkbox"/>	12	\$781	<input type="checkbox"/>	14	\$781	<input type="checkbox"/>	16	\$781	<input type="checkbox"/>	18	\$781	<input type="checkbox"/>	20	\$781
	15.0" (T)	4.5"	8.5"	J3PLMTTxxSH	<input type="checkbox"/>	12	\$729	<input type="checkbox"/>	14	\$729	<input type="checkbox"/>	16	\$729	<input type="checkbox"/>	18	\$729	<input type="checkbox"/>	20	\$729
				J3PLMTTxxFS	<input type="checkbox"/>	12	\$781	<input type="checkbox"/>	14	\$781	<input type="checkbox"/>	16	\$781	<input type="checkbox"/>	18	\$781	<input type="checkbox"/>	20	\$781
				J3PLMTTxxTH	<input type="checkbox"/>	12	\$781	<input type="checkbox"/>	14	\$781	<input type="checkbox"/>	16	\$781	<input type="checkbox"/>	18	\$781	<input type="checkbox"/>	20	\$781
Upper Thoracic (UT)	16.5" (S)	5.5"	7.5"	J3PLUTSxxSH	<input type="checkbox"/>	12	\$729	<input type="checkbox"/>	14	\$729	<input type="checkbox"/>	16	\$729	<input type="checkbox"/>	18	\$729	<input type="checkbox"/>	20	\$729
				J3PLUTSxxFS	<input type="checkbox"/>	12	\$781	<input type="checkbox"/>	14	\$781	<input type="checkbox"/>	16	\$781	<input type="checkbox"/>	18	\$781	<input type="checkbox"/>	20	\$781
				J3PLUTSxxTH	<input type="checkbox"/>	12	\$781	<input type="checkbox"/>	14	\$781	<input type="checkbox"/>	16	\$781	<input type="checkbox"/>	18	\$781	<input type="checkbox"/>	20	\$781
	18.0" (M)	5.5"	8.5"	J3PLUTMxxSH	<input type="checkbox"/>	14	\$729	<input type="checkbox"/>	16	\$729	<input type="checkbox"/>	18	\$729	<input type="checkbox"/>	20	\$729			
				J3PLUTMxxFS	<input type="checkbox"/>	14	\$781	<input type="checkbox"/>	16	\$781	<input type="checkbox"/>	18	\$781	<input type="checkbox"/>	20	\$781			
				J3PLUTMxxTH	<input type="checkbox"/>	14	\$781	<input type="checkbox"/>	16	\$781	<input type="checkbox"/>	18	\$781	<input type="checkbox"/>	20	\$781			
	19.5" (T)	5.5"	9.5"	J3PLUTTxxSH	<input type="checkbox"/>	14	\$729	<input type="checkbox"/>	16	\$729	<input type="checkbox"/>	18	\$729	<input type="checkbox"/>	20	\$729			
				J3PLUTTxxFS	<input type="checkbox"/>	14	\$781	<input type="checkbox"/>	16	\$781	<input type="checkbox"/>	18	\$781	<input type="checkbox"/>	20	\$781			
				J3PLUTTxxTH	<input type="checkbox"/>	14	\$781	<input type="checkbox"/>	16	\$781	<input type="checkbox"/>	18	\$781	<input type="checkbox"/>	20	\$781			
Shoulder Height (SH)	21.0" (S)	5.5"	8.5"	J3PLSHSxxSH	<input type="checkbox"/>	14	\$729	<input type="checkbox"/>	16	\$729	<input type="checkbox"/>	18	\$729	<input type="checkbox"/>	20	\$729			
				J3PLSHSxxFS	<input type="checkbox"/>	14	\$781	<input type="checkbox"/>	16	\$781	<input type="checkbox"/>	18	\$781	<input type="checkbox"/>	20	\$781			
				J3PLSHSxxTH	<input type="checkbox"/>	14	\$781	<input type="checkbox"/>	16	\$781	<input type="checkbox"/>	18	\$781	<input type="checkbox"/>	20	\$781			
	22.5" (M)	5.5"	9.5"	J3PLSHMxxSH	<input type="checkbox"/>	16	\$729	<input type="checkbox"/>	18	\$729	<input type="checkbox"/>	20	\$729						
				J3PLSHMxxFS	<input type="checkbox"/>	16	\$781	<input type="checkbox"/>	18	\$781	<input type="checkbox"/>	20	\$781						
				J3PLSHMxxTH	<input type="checkbox"/>	16	\$781	<input type="checkbox"/>	18	\$781	<input type="checkbox"/>	20	\$781						
	24.0" (T)	5.5"	10.5"	J3PLSHTxxSH	<input type="checkbox"/>	18	\$729	<input type="checkbox"/>	20	\$729									
				J3PLSHTxxFS	<input type="checkbox"/>	18	\$781	<input type="checkbox"/>	20	\$781									
				J3PLSHTxxTH	<input type="checkbox"/>	18	\$781	<input type="checkbox"/>	20	\$781									

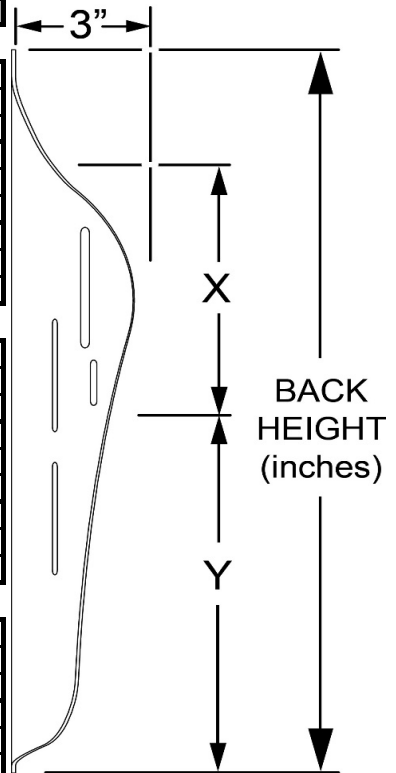

Note: Hardware choices are not offered on every size of J3 Backrest, only options listed above are available.

MOUNTING HARDWARE OPTIONS

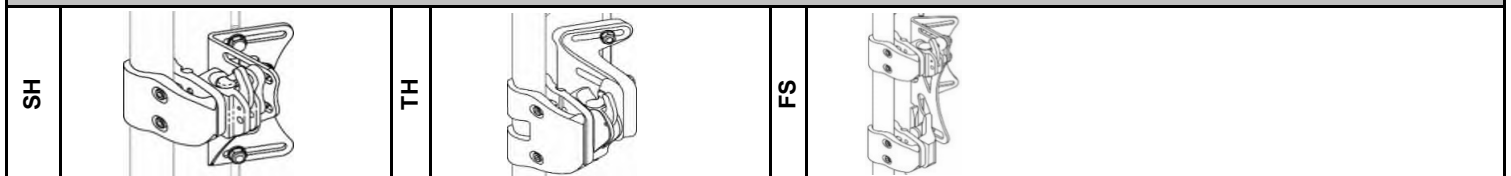



JAY[®] J3 Posterior Deep (PD) Backrest

E2620

January 2025

Mark For: _____
 Date: _____
 Dealer Acct #: _____
 Dealer: _____
 Dealer Contact: _____
 Dealer Address: _____
 Dealer City: _____ ST: _____ ZIP: _____
 Dealer Phone: () _____ Fax: () _____
 Confirmation Email: _____
 Confirm Via: Fax Email

Submitting for: Quote Order
 PO#: _____
ADDITIONAL SHIPPING INFORMATION
 Ship To: _____
 Attention: _____
 Address: _____
 Address: _____
 Ship To City: _____ ST: _____ ZIP: _____
 Ship To Phone: () _____ Fax: () _____

The HCPCS CODES herein are based on PDAC verification or interpretation of Medicare definitions and guidelines. Non-Medicare payers may accept alternative HCPCS CODES, including misc. codes to ensure access for their enrollees. The use of HCPCS CODES does not ensure coverage or payment.

JAY J3 Posterior Deep (PD) Back - E2620



BACKREST WIDTH	12"	14"	16"	18"	20"
BACKCANE WIDTHS	12"- 14"	14"- 16"	16"- 18"	18"- 20"	20"- 22"
MAX. USER TRUNK WIDTH	11"	11"	13"	15"	17"

Back Height	Lower Thoracic (LT)		Mid Thoracic (MT)		Upper Thoracic (UT)		Shoulder Height (SH)		
	Options	Price	Options	Price	Options	Price	Options	Price	
6.5" (S)	J3PDLTMxxSH	\$875	J3PDMTSxxSH	\$875	J3PDUTSxxSH	\$875	J3PDSHSxxSH	\$875	
	J3PDLTMxxRH	\$928	J3PDMTSxxFS	\$928	J3PDUTSxxFS	\$928	J3PDSHSxxFS	\$928	
	J3PDLTMxxRHF	\$928	J3PDMTSxxTH	\$928	J3PDUTSxxTH	\$928	J3PDSHSxxTH	\$928	
	J3PDLTTxxSH	\$875	J3PDMTMxxSH	\$875	J3PDUTMxxSH	\$875	J3PDSHMxxSH	\$875	
	J3PDLTTxxRH	\$928	J3PDMTMxxFS	\$928	J3PDUTMxxFS	\$928	J3PDSHMxxFS	\$928	
	J3PDLTTxxRHF	\$928	J3PDMTMxxTH	\$928	J3PDUTMxxTH	\$928	J3PDSHMxxTH	\$928	
	J3PDLTTxxSH	\$875	J3PDMTTxxSH	\$875	J3PDUTTxxSH	\$875	J3PDSHTxxSH	\$875	
	J3PDLTTxxRH	\$928	J3PDMTTxxFS	\$928	J3PDUTTxxFS	\$928	J3PDSHTxxFS	\$928	
	J3PDLTTxxRHF	\$928	J3PDMTTxxTH	\$928	J3PDUTTxxTH	\$928	J3PDSHTxxTH	\$928	
	21.0" (S)		22.5" (M)		24.0" (T)				
	12		14		16		18		20
	18		20		22				

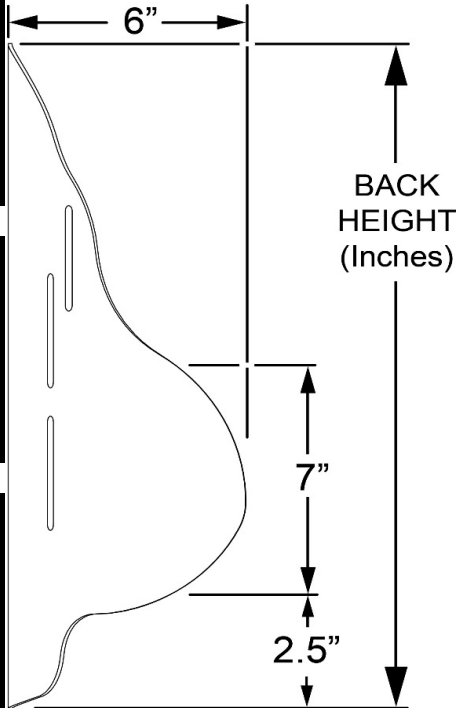

Note: Hardware choices are not offered on every size of J3 Backrest, only options listed above are available.

MOUNTING HARDWARE OPTIONS

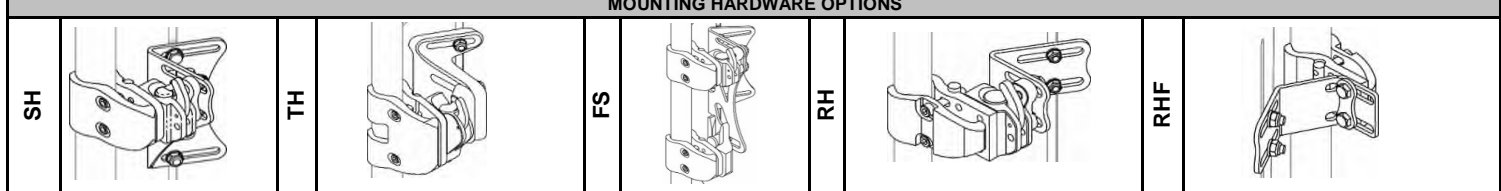



JAY® J3 Posterior Deep Lateral (PDL) Backrest

E2620

January 2025

Mark For: _____
 Date: _____
 Dealer Acct #: _____
 Dealer: _____
 Dealer Contact: _____
 Dealer Address: _____
 Dealer City: _____ ST: _____ ZIP: _____
 Dealer Phone: () _____ Fax: () _____
 Confirmation Email: _____
 Confirm Via: Fax Email

Submitting for: Quote Order
 PO#: _____
ADDITIONAL SHIPPING INFORMATION
 Ship To: _____
 Attention: _____
 Address: _____
 Address: _____
 Ship To City: _____ ST: _____ ZIP: _____
 Ship To Phone: () _____ Fax () _____

The **HCPCS CODES** herein are based on PDAC verification or interpretation of Medicare definitions and guidelines. Non-Medicare payers may accept alternative **HCPCS CODES**, including misc. codes to ensure access for their enrollees. The use of **HCPCS CODES** does not ensure coverage or payment.

JAY J3 Posterior Deep Lateral (PDL) Back - E2620

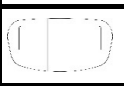
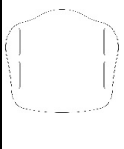
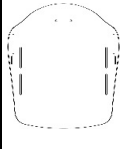
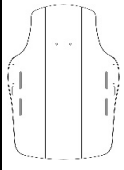

BACKREST WIDTH	14"	16"	18"	20"
BACKCANE WIDTHS	14"- 16"	16"- 18"	18"- 20"	20"- 22"
MAX. USER TRUNK WIDTH	11"	13"	15"	17"

Back Height	Lower Thoracic (LT)		X	Y												
	6.5" (S)															
	8.0" (M)															
	9.5" (T)															
	Mid Thoracic (MT)		X	Y												
	12.0" (S)															
	13.5" (M)															
	Upper Thoracic (UT)		X	Y												
	16.5" (S)	7.5"	5.8"	J3PDLUTSxxSH	<input type="checkbox"/>	14	\$875	<input type="checkbox"/>	16	\$875	<input type="checkbox"/>	18	\$875	<input type="checkbox"/>	20	\$875
				J3PDLUTSxxFS	<input type="checkbox"/>	14	\$928	<input type="checkbox"/>	16	\$928	<input type="checkbox"/>	18	\$928	<input type="checkbox"/>	20	\$928
				J3PDLUTSxxTH	<input type="checkbox"/>	14	\$928	<input type="checkbox"/>	16	\$928	<input type="checkbox"/>	18	\$928	<input type="checkbox"/>	20	\$928
	18.0" (M)	8.3"	6.5"	J3PDLUTMxxSH	<input type="checkbox"/>	14	\$875	<input type="checkbox"/>	16	\$875	<input type="checkbox"/>	18	\$875	<input type="checkbox"/>	20	\$875
				J3PDLUTMxxFS	<input type="checkbox"/>	14	\$928	<input type="checkbox"/>	16	\$928	<input type="checkbox"/>	18	\$928	<input type="checkbox"/>	20	\$928
J3PDLUTMxxTH				<input type="checkbox"/>	14	\$928	<input type="checkbox"/>	16	\$928	<input type="checkbox"/>	18	\$928	<input type="checkbox"/>	20	\$928	
19.5" (T)	9.3"	6.8"	J3PDLUTTxxSH	<input type="checkbox"/>	14	\$875	<input type="checkbox"/>	16	\$875	<input type="checkbox"/>	18	\$875	<input type="checkbox"/>	20	\$875	
			J3PDLUTTxxFS	<input type="checkbox"/>	14	\$928	<input type="checkbox"/>	16	\$928	<input type="checkbox"/>	18	\$928	<input type="checkbox"/>	20	\$928	
			J3PDLUTTxxTH	<input type="checkbox"/>	14	\$928	<input type="checkbox"/>	16	\$928	<input type="checkbox"/>	18	\$928	<input type="checkbox"/>	20	\$928	
	Shoulder Height (SH)		X	Y												
	21.0" (S)	8"	6"	J3PDLSHSxxSH	<input type="checkbox"/>	14	\$875	<input type="checkbox"/>	16	\$875	<input type="checkbox"/>	18	\$875	<input type="checkbox"/>	20	\$875
				J3PDLSHSxxFS	<input type="checkbox"/>	14	\$928	<input type="checkbox"/>	16	\$928	<input type="checkbox"/>	18	\$928	<input type="checkbox"/>	20	\$928
				J3PDLSHSxxTH	<input type="checkbox"/>	14	\$928	<input type="checkbox"/>	16	\$928	<input type="checkbox"/>	18	\$928	<input type="checkbox"/>	20	\$928
	22.5" (M)	8.8"	6.5"	J3PDLSHMxxSH				<input type="checkbox"/>	16	\$875	<input type="checkbox"/>	18	\$875	<input type="checkbox"/>	20	\$875
				J3PDLSHMxxFS				<input type="checkbox"/>	16	\$928	<input type="checkbox"/>	18	\$928	<input type="checkbox"/>	20	\$928
				J3PDLSHMxxTH				<input type="checkbox"/>	16	\$928	<input type="checkbox"/>	18	\$928	<input type="checkbox"/>	20	\$928
	24.0" (T)	9.5"	7.3"	J3PDLSHTxxSH						<input type="checkbox"/>	18	\$875	<input type="checkbox"/>	20	\$875	
				J3PDLSHTxxFS						<input type="checkbox"/>	18	\$928	<input type="checkbox"/>	20	\$928	
J3PDLSHTxxTH									<input type="checkbox"/>	18	\$928	<input type="checkbox"/>	20	\$928		

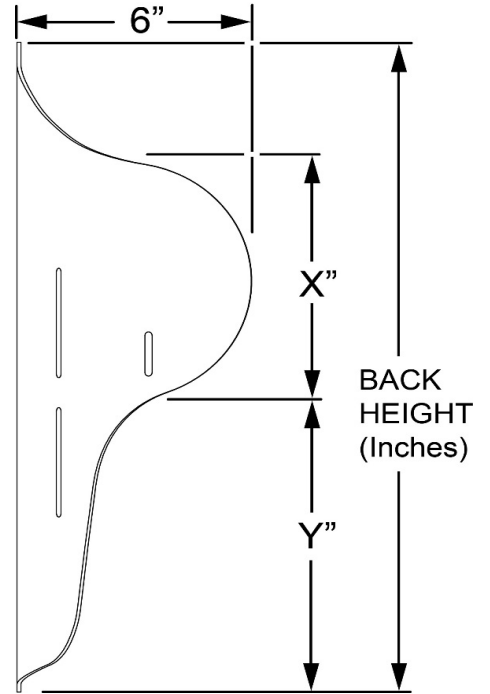

Note: Hardware choices are not offered on every size of J3 Backrest, only options listed above are available.

MOUNTING HARDWARE OPTIONS

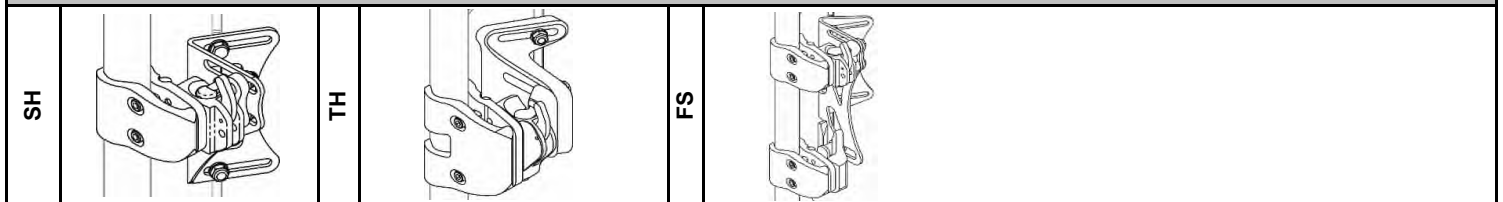



JAY® J3 Posterior Deep Contour (PDC) Backrest

E2620

January 2025

Mark For: _____
 Date: _____
 Dealer Acct #: _____
 Dealer: _____
 Dealer Contact: _____
 Dealer Address: _____
 Dealer City: _____ ST: _____ ZIP: _____
 Dealer Phone: () _____ Fax: () _____
 Confirmation Email: _____
 Confirm Via: Fax Email

Submitting for: Quote Order
 PO#: _____

ADDITIONAL SHIPPING INFORMATION

Ship To: _____
 Attention: _____
 Address: _____
 Address: _____
 Ship To City: _____ ST: _____ ZIP: _____
 Ship To Phone: () _____ Fax () _____

The **HCPCS CODES** herein are based on PDAC verification or interpretation of Medicare definitions and guidelines. Non-Medicare payers may accept alternative **HCPCS CODES**, including misc. codes to ensure access for their enrollees. The use of **HCPCS CODES** does not ensure coverage or payment.

JAY J3 Posterior Deep Contour (PDC) Back - E2620



BACKREST WIDTH	14"	16"	18"	20"
BACKCANE WIDTHS	14"- 16"	16"- 18"	18"- 20"	20"- 22"
MAX. USER TRUNK WIDTH	11"	13"	15"	17"

		Lower Thoracic (LT)	X	Y																
Back Height		6.5" (S)																		
		8.0" (M)	5"	.5"	J3PDCLTMxxSH	<input type="checkbox"/>	14	\$875	<input type="checkbox"/>	16	\$875	<input type="checkbox"/>	18	\$875						
					J3PDCLTMxxRH	<input type="checkbox"/>	14	\$875	<input type="checkbox"/>	16	\$875	<input type="checkbox"/>	18	\$875						
					J3PDCLTMxxRHF	<input type="checkbox"/>	14	\$875	<input type="checkbox"/>	16	\$875	<input type="checkbox"/>	18	\$875						
		9.5" (T)	5.2"	.5"	J3PDCLTTxxSH	<input type="checkbox"/>	14	\$875	<input type="checkbox"/>	16	\$875	<input type="checkbox"/>	18	\$875	<input type="checkbox"/>	20	\$875			
					J3PDCLTTxxRH	<input type="checkbox"/>	14	\$875	<input type="checkbox"/>	16	\$875	<input type="checkbox"/>	18	\$875	<input type="checkbox"/>	20	\$875			
	J3PDCLTTxxRHF				<input type="checkbox"/>	14	\$875	<input type="checkbox"/>	16	\$875	<input type="checkbox"/>	18	\$875	<input type="checkbox"/>	20	\$875				
			Mid Thoracic (MT)	X	Y															
		12.0" (S)	5.5"	.5"	J3PDCMTSxxSH	<input type="checkbox"/>	14	\$875	<input type="checkbox"/>	16	\$875	<input type="checkbox"/>	18	\$875	<input type="checkbox"/>	20	\$875			
					J3PDCMTSxxFS	<input type="checkbox"/>	14	\$891	<input type="checkbox"/>	16	\$891	<input type="checkbox"/>	18	\$891	<input type="checkbox"/>	20	\$891			
					J3PDCMTSxxTH	<input type="checkbox"/>	14	\$928	<input type="checkbox"/>	16	\$928	<input type="checkbox"/>	18	\$928	<input type="checkbox"/>	20	\$928			
		13.5" (M)																		
15.0" (T)					6.5"	.5"	J3PDCMTTxxSH	<input type="checkbox"/>	14	\$875	<input type="checkbox"/>	16	\$875	<input type="checkbox"/>	18	\$875	<input type="checkbox"/>	20	\$875	
							J3PDCMTTxxFS	<input type="checkbox"/>	14	\$891	<input type="checkbox"/>	16	\$891	<input type="checkbox"/>	18	\$891	<input type="checkbox"/>	20	\$891	
J3PDCMTTxxTH	<input type="checkbox"/>	14	\$928	<input type="checkbox"/>	16	\$928	<input type="checkbox"/>	18	\$928	<input type="checkbox"/>	20	\$928								
		Upper Thoracic (UT)	X	Y																
	16.5" (S)																			
				18.0" (M)	6.5"	.5"	J3PDCUTMxxSH	<input type="checkbox"/>	14	\$875	<input type="checkbox"/>	16	\$875	<input type="checkbox"/>	18	\$875	<input type="checkbox"/>	20	\$875	
							J3PDCUTMxxFS	<input type="checkbox"/>	14	\$891	<input type="checkbox"/>	16	\$891	<input type="checkbox"/>	18	\$891	<input type="checkbox"/>	20	\$891	
	J3PDCUTMxxTH	<input type="checkbox"/>	14	\$928	<input type="checkbox"/>	16	\$928	<input type="checkbox"/>	18	\$928	<input type="checkbox"/>	20	\$928							
19.5" (T)																				
		Shoulder Height (SH)	X	Y																
	21.0" (S)	6.5"	.5"	J3PDCSHSxxSH				<input type="checkbox"/>	16	\$875	<input type="checkbox"/>	18	\$875	<input type="checkbox"/>	20	\$875				
				J3PDCSHSxxFS				<input type="checkbox"/>	16	\$891	<input type="checkbox"/>	18	\$891	<input type="checkbox"/>	20	\$891				
				J3PDCSHSxxTH				<input type="checkbox"/>	16	\$928	<input type="checkbox"/>	18	\$928	<input type="checkbox"/>	20	\$928				
	22.5" (M)																			
24.0" (T)																				

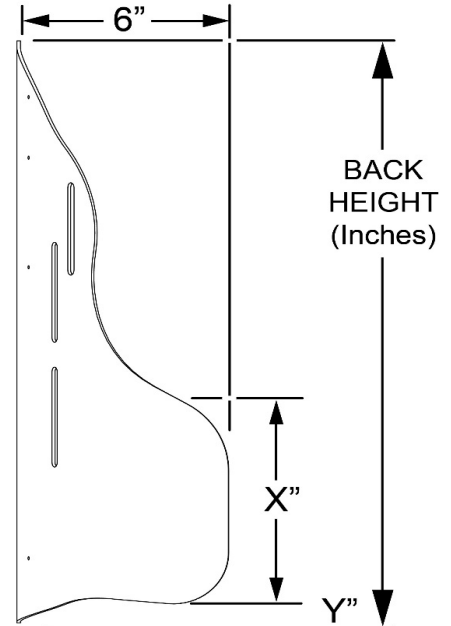

Note: Hardware choices are not offered on every size of J3 Backrest, only options listed above are available.

MOUNTING HARDWARE OPTIONS

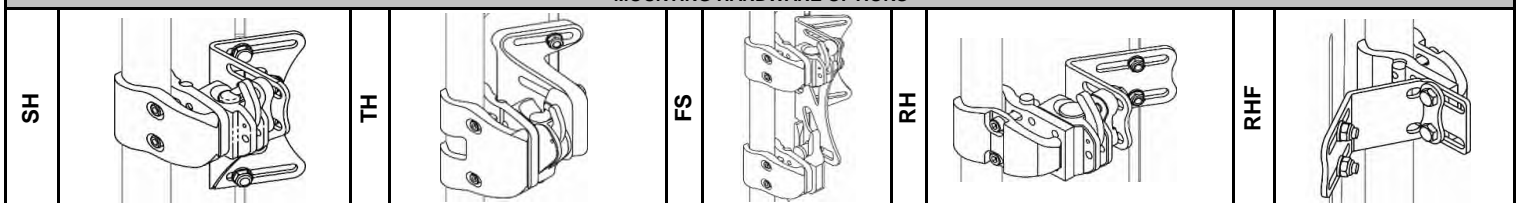

JAY J3 Back Accessories

All JAY J3 Back accessories are optional. All accessories will be factory mounted as much as possible to insure proper shipping (If selected below).

SHIPPING INSTRUCTIONS

<input type="checkbox"/>	N/A	Ship Back on Chair (Chair to be ordered separately)	N/C	<input type="checkbox"/>	N/A	Ship accessories mounted on back	N/C
--------------------------	-----	---	-----	--------------------------	-----	----------------------------------	-----

Headrests

Use this section for selecting headrest. Head supports are not available on LT Back Shells

STEP 1

Select your HEADREST POST

Please select one box from the below **Headrest Mount & Bracket** choices.

✓	Option #	HCPCS	Definition	Price	✓	Option #	HCPCS	Definition	Price
<input type="checkbox"/>	J3HEDX	E1028	Axys Mount & Bracket	\$259.00	<input type="checkbox"/>	J3HEDO	E1028	ONYX Mount & Bracket	\$234.00
<input type="checkbox"/>	J3HEDL	E1028	LINX Mount & Bracket	\$330.00	<input type="checkbox"/>	J3HEDC	E1028	Cobra Mount & Bracket	\$326.00
<input type="checkbox"/>	J3HEDL2	E1028	LINX ² Mount & Bracket	\$362.00	<input type="checkbox"/>	J3HEDF	E1028	Cobra Flip Back Mount and Bracket	\$393.00



STEP 2

Select your HEADREST PAD

Please select one box from the below **Headrest Pad** choices.

<input type="checkbox"/>	14	E0955	J3PLSH14 - 14" Plush Pad	\$205.00	<input type="checkbox"/>	AAPS	E0955	J3AAPS - Adjust-A-Plush Standard (Lg)	\$307.00
<input type="checkbox"/>	10	E0955	J3PLSH10 - 10" Plush Pad	\$190.00	<input type="checkbox"/>	AAPM	E0955	J3AAPM - Adjust-A-Plush Medium	\$307.00
<input type="checkbox"/>	8	E0955	J3PLSH8 - 8" Plush Pad	\$190.00	<input type="checkbox"/>	AAPN	E0955	J3AAPN - Adjust-A-Plush Narrow (Sm)	\$307.00
<input type="checkbox"/>	HUPL	E0955	J3HUPL - HeadsUp Lrg: 5.3" Lng Arms	\$365.00	<input type="checkbox"/>	CL	E0955	J3CRDLLG - Lrg Contour Cradle Pad	\$183.00
<input type="checkbox"/>	HUPM	E0955	J3HUPM - HeadsUp Med: 4.1" Sht Arms	\$365.00	<input type="checkbox"/>	CM	E0955	J3CRDLMD - Med Contour Cradle Pad	\$169.00
<input type="checkbox"/>	HUPS	E0955	J3HUPS - HeadsUp Sml: 3.5" Sht Arms	\$365.00	<input type="checkbox"/>	PL	E0955	J3CPLULG - Large C-Plush Pad	\$183.00
					<input type="checkbox"/>	PM	E0955	J3CPLUMD - Medium C-Plush Pad	\$183.00

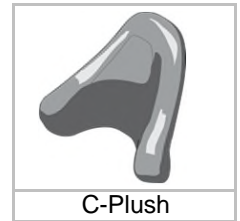
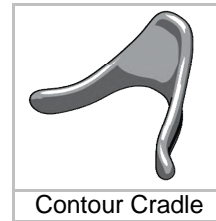
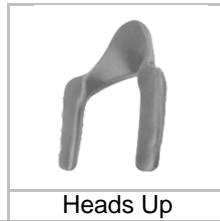
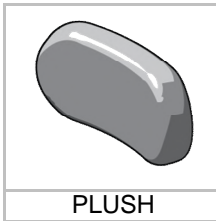

STEP 1 - Headrest Post		+	STEP 2 - Headrest Pad #		=	Completed JAY J3 Headrest #	
Example = J3HEDX			Example = 14			Example = J3HEDX14	

Universal Mounting Plate

<input type="checkbox"/>	J3UHM	K0108	Universal Headrest Mounting Plate Only	\$61.00
--------------------------	-------	-------	--	---------

Lateral Supports

Use this section for selecting laterals and hardware. Lateral supports are not available on Lower Thoracic Back Shells

Lateral Thoracic Support (Fixed)

Includes fixed mounting hardware. Lateral pads use 3DX covers with 1/2" Sunmate foam in the core

<input type="checkbox"/>	J3LAT4X4FX	E0956	LATERAL 4" Depth X 4" Height FIXED	\$293.00	<input type="checkbox"/>	J3LAT6X4FX	E0956	LATERAL 6" Depth X 4" Height FIXED	\$293.00
<input type="checkbox"/>	J3LAT4X5FX	E0956	LATERAL 4" Depth X 5" Height FIXED	\$293.00	<input type="checkbox"/>	J3LAT6X5FX	E0956	LATERAL 6" Depth X 5" Height FIXED	\$293.00
<input type="checkbox"/>	J3LAT4X6FX	E0956	LATERAL 4" Depth X 6" Height FIXED	\$293.00	<input type="checkbox"/>	J3LAT6X6FX	E0956	LATERAL 6" Depth X 6" Height FIXED	\$293.00

Swing-Away Lateral Thoracic Support

Includes: Swing-away mounting hardware, left and right lateral are independent. Different types and sizes can be selected for each side.

Left Side					Right Side				
<input type="checkbox"/>	JLATSA44L		LAT 4X4 W/ S/A MOUNTS - LH	\$455.00	<input type="checkbox"/>	JLATSA44R		LAT 4X4 W/ S/A MOUNTS - RH	\$455.00
	JLAT4X4	E0956	Lateral 4" Depth X 4" Height	\$147.00		JLAT4X4	E0956	Lateral 4" Depth X 4" Height	\$147.00
	JSAMNTL	E1028	Lateral Swing Away Mount - Left	\$308.00		JSAMNTR	E1028	Lateral Swing Away Mount - Right	\$308.00
<input type="checkbox"/>	JLATSA45L		LAT 4X5 W/ S/A MOUNTS - LH	\$455.00	<input type="checkbox"/>	JLATSA45R		LAT 4X5 W/ S/A MOUNTS - RH	\$455.00
	JLAT4X5	E0956	LATERAL 4" Depth X 5" Height	\$147.00		JLAT4X5	E0956	Lateral 4" Depth X 5" Height	\$147.00
	JSAMNTL	E1028	Lateral Swing Away Mount - Left	\$308.00		JSAMNTR	E1028	Lateral Swing Away Mount - Right	\$308.00
<input type="checkbox"/>	JLATSA46L		LAT 4X6 W/ S/A MOUNTS - LH	\$455.00	<input type="checkbox"/>	JLATSA46R		LAT 4X6 W/ S/A MOUNTS - RH	\$455.00
	JLAT4X6	E0956	LATERAL 4" Depth X 6" Height	\$147.00		JLAT4X6	E0956	Lateral 4" Depth X 6" Height	\$147.00
	JSAMNTL	E1028	Lateral Swing Away Mount - Left	\$308.00		JSAMNTR	E1028	Lateral Swing Away Mount - Right	\$308.00
<input type="checkbox"/>	JLATSA64L		LAT 6X4 W/ S/A MOUNTS - LH	\$455.00	<input type="checkbox"/>	JLATSA64R		LAT 6X4 W/ S/A MOUNTS - RH	\$455.00
	JLAT6X4	E0956	LATERAL 6" Depth X 4" Height	\$147.00		JLAT6X4	E0956	Lateral 6" Depth X 4" Height	\$147.00
	JSAMNTL	E1028	Lateral Swing Away Mount - Left	\$308.00		JSAMNTR	E1028	Lateral Swing Away Mount - Right	\$308.00
<input type="checkbox"/>	JLATSA65L		LAT 6X5 W/ S/A MOUNTS - LH	\$455.00	<input type="checkbox"/>	JLATSA65R		LAT 6X5 W/ S/A MOUNTS - RH	\$455.00
	JLAT6X5	E0956	LATERAL 6" Depth X 5" Height	\$147.00		JLAT6X5	E0956	Lateral 6" Depth X 5" Height	\$147.00
	JSAMNTL	E1028	Lateral Swing Away Mount - Left	\$308.00		JSAMNTR	E1028	Lateral Swing Away Mount - Right	\$308.00
<input type="checkbox"/>	JLATSA66L		LAT 6X6 W/ S/A MOUNTS - LH	\$455.00	<input type="checkbox"/>	JLATSA66R		LAT 6X6 W/ S/A MOUNTS - RH	\$455.00
	JLAT6X6	E0956	LATERAL 6" Depth X 6" Height	\$147.00		JLAT6X6	E0956	Lateral 6" Depth X 6" Height	\$147.00
	JSAMNTL	E1028	Lateral Swing Away Mount - Left	\$308.00		JSAMNTR	E1028	Lateral Swing Away Mount - Right	\$308.00

Rotational Swing-Away Lateral Thoracic Support

Includes: Rotational swing-away mounting hardware, left and right lateral are independent. Different types and sizes can be selected for each side.

Left Side					Right Side				
<input type="checkbox"/>	JLATRSA44L		LAT 4X4 W/ S/A MOUNTS - LH	\$512.00	<input type="checkbox"/>	JLATRSA44R		LAT 4X4 W/ S/A MOUNTS - RH	\$512.00
	JLAT4X4	E0956	Lateral 4" Depth X 4" Height	\$147.00		JLAT4X4	E0956	Lateral 4" Depth X 4" Height	\$147.00
	JRSAMNTL	E1028	Lateral Swing Away Mount - Left	\$365.00		JRSAMNTR	E1028	Lateral Swing Away Mount - Right	\$365.00
<input type="checkbox"/>	JLATRSA45L		LAT 4X5 W/ S/A MOUNTS - LH	\$512.00	<input type="checkbox"/>	JLATRSA45R		LAT 4X5 W/ S/A MOUNTS - RH	\$512.00
	JLAT4X5	E0956	LATERAL 4" Depth X 5" Height	\$147.00		JLAT4X5	E0956	Lateral 4" Depth X 5" Height	\$147.00
	JRSAMNTL	E1028	Lateral Swing Away Mount - Left	\$365.00		JRSAMNTR	E1028	Lateral Swing Away Mount - Right	\$365.00
<input type="checkbox"/>	JLATRSA46L		LAT 4X6 W/ S/A MOUNTS - LH	\$512.00	<input type="checkbox"/>	JLATRSA46R		LAT 4X6 W/ S/A MOUNTS - RH	\$512.00
	JLAT4X6	E0956	LATERAL 4" Depth X 6" Height	\$147.00		JLAT4X6	E0956	Lateral 4" Depth X 6" Height	\$147.00
	JRSAMNTL	E1028	Lateral Swing Away Mount - Left	\$365.00		JRSAMNTR	E1028	Lateral Swing Away Mount - Right	\$365.00
<input type="checkbox"/>	JLATRSA64L		LAT 6X4 W/ S/A MOUNTS - LH	\$512.00	<input type="checkbox"/>	JLATRSA64R		LAT 6X4 W/ S/A MOUNTS - RH	\$512.00
	JLAT6X4	E0956	LATERAL 6" Depth X 4" Height	\$147.00		JLAT6X4	E0956	Lateral 6" Depth X 4" Height	\$147.00
	JRSAMNTL	E1028	Lateral Swing Away Mount - Left	\$365.00		JRSAMNTR	E1028	Lateral Swing Away Mount - Right	\$365.00
<input type="checkbox"/>	JLATRSA65L		LAT 6X5 W/ S/A MOUNTS - LH	\$512.00	<input type="checkbox"/>	JLATRSA65R		LAT 6X5 W/ S/A MOUNTS - RH	\$512.00
	JLAT6X5	E0956	LATERAL 6" Depth X 5" Height	\$147.00		JLAT6X5	E0956	Lateral 6" Depth X 5" Height	\$147.00
	JRSAMNTL	E1028	Lateral Swing Away Mount - Left	\$365.00		JRSAMNTR	E1028	Lateral Swing Away Mount - Right	\$365.00
<input type="checkbox"/>	JLATRSA66L		LAT 6X6 W/ S/A MOUNTS - LH	\$512.00	<input type="checkbox"/>	JLATRSA66R		LAT 6X6 W/ S/A MOUNTS - RH	\$512.00
	JLAT6X6	E0956	LATERAL 6" Depth X 6" Height	\$147.00		JLAT6X6	E0956	Lateral 6" Depth X 6" Height	\$147.00
	JRSAMNTL	E1028	Lateral Swing Away Mount - Left	\$365.00		JRSAMNTR	E1028	Lateral Swing Away Mount - Right	\$365.00

Spine-Align Positioning Components

J3 Back LT models come standard with a Small Lumbar, MT,UT and SH models come standard with a small and large lumbar.

SPINE-ALIGN MINI FIT KIT 1

Includes: 3 wedges, 2 lateral shims, and 2 posterior/lateral pelvic positioning pads.

<input type="checkbox"/>	J3SPNK112	K0108	SPINE-ALIGN MINI FIT KIT 1 (12")	\$117.00
<input type="checkbox"/>	J3SPNK114	K0108	SPINE-ALIGN MINI FIT KIT 1 (14")	\$117.00
<input type="checkbox"/>	J3SPNK116	K0108	SPINE-ALIGN MINI FIT KIT 1 (16")	\$117.00
<input type="checkbox"/>	J3SPNK118	K0108	SPINE-ALIGN MINI FIT KIT 1 (18")	\$117.00
<input type="checkbox"/>	J3SPNK120	K0108	SPINE-ALIGN MINI FIT KIT 1 (20")	\$117.00

LARGE LUMBAR PADS (Back Width) (W" x H" x D")

<input type="checkbox"/>	J3SPNLL12	K0108	LG LUMBAR (12") (3.5" x 7" x 1.6")	\$51.00
<input type="checkbox"/>	J3SPNLL14	K0108	LG LUMBAR (14") (3.5" x 7" x 1.6")	\$51.00
<input type="checkbox"/>	J3SPNLL16	K0108	LG LUMBAR (16") (5.5" x 7" x 1.6")	\$51.00
<input type="checkbox"/>	J3SPNLL18	K0108	LG LUMBAR (18") (7.5" x 7" x 1.6")	\$51.00
<input type="checkbox"/>	J3SPNLL20	K0108	LG LUMBAR (20") (9.5" x 7" x 1.6")	\$51.00

WEDGES (Back Width) (W" x H" x D")

<input type="checkbox"/>	J3SPNWE12	K0108	WEDGES (12") (3.5" x 6.5" x 1.6")	\$38.00
<input type="checkbox"/>	J3SPNWE14	K0108	WEDGES (14") (3.5" x 6.5" x 1.6")	\$38.00
<input type="checkbox"/>	J3SPNWE16	K0108	WEDGES (16") (5.5" x 6.5" x 1.6")	\$38.00
<input type="checkbox"/>	J3SPNWE18	K0108	WEDGES (18") (7.5" x 6.5" x 1.6")	\$38.00
<input type="checkbox"/>	J3SPNWE20	K0108	WEDGES (20") (9.5" x 6.5" x 1.6")	\$38.00

SPINE-ALIGN MINI FIT KIT 2

Includes: 5 wedges, 2 lat shims, 2 post/lat pelvic, 1 lg lumbar, 1 flat shim, and 1 curved







<input type="checkbox"/>	J3SPNK212	K0108	SPINE-ALIGN MINI FIT KIT 2 (12")	\$162.00
<input type="checkbox"/>	J3SPNK214	K0108	SPINE-ALIGN MINI FIT KIT 2 (14")	\$162.00
<input type="checkbox"/>	J3SPNK216	K0108	SPINE-ALIGN MINI FIT KIT 2 (16")	\$162.00
<input type="checkbox"/>	J3SPNK218	K0108	SPINE-ALIGN MINI FIT KIT 2 (18")	\$162.00
<input type="checkbox"/>	J3SPNK220	K0108	SPINE-ALIGN MINI FIT KIT 2 (20")	\$162.00

SMALL LUMBAR PADS (Back Width) (W" x H" x D")

<input type="checkbox"/>	J3SPNSL12	K0108	SML LUMBAR (12") (1.8" x 3.2" x 0.8")	\$49.00
<input type="checkbox"/>	J3SPNSL14	K0108	SML LUMBAR (14") (3.5" x 4.3" x 1")	\$49.00
<input type="checkbox"/>	J3SPNSL16	K0108	SML LUMBAR (16") (5.5" x 4.3" x 1")	\$49.00
<input type="checkbox"/>	J3SPNSL18	K0108	SML LUMBAR (18") (7.5" x 4.3" x 1")	\$49.00
<input type="checkbox"/>	J3SPNSL20	K0108	SML LUMBAR (20") (9.5" x 4.3" x 1")	\$49.00

OTHER INDIVIDUAL SPINE-ALIGN COMPONENTS

<input type="checkbox"/>	J3SPNCR	K0108	Curved Shim	\$29.00
<input type="checkbox"/>	J3SPNBS	K0108	Small Bean Bag	\$32.00
<input type="checkbox"/>	J3SPNFL	K0108	Flat Shim	\$29.00
<input type="checkbox"/>	J3SPNBL	K0108	Large Bean Bag	\$35.00
<input type="checkbox"/>	J3SPNLS	K0108	Lateral Shim	\$55.00
<input type="checkbox"/>	J3SPNLP	K0108	Posterior/Lateral Pelvic	\$55.00

									
	Sm Lumbar	Lg Lumbar	Wedge	Curved Slim	Flat	Lateral Slim	Sm Bean Bag	Lg Bean Bag	Post/Lat Pelvic
W	1.8" - 9.5"	3.5" - 9.5"	3.5" - 9.5"	10"	10"	2.4"	6"	10"	5.3"
H	3.2" - 4.3"	7"	6.5"	4"	4"	4.3"	4.5"	3.2"	3.6"
D	0.8" - 1"	1.6"	1.6"	0.5"	0.3"	0.5"	0.75"	0.75"	0.75"

Chest Straps, Harnesses and Brackets

Use this section for selecting harnesses. Harnesses are not available on Lower Thoracic Back Shells

CHEST STRAPS & HARNESSES *(Includes strap guides & mounting hardware)*

<input type="checkbox"/>	J3HRNCOS	E0960	Center Opening w/ Buckle (Sml)	\$177.00	<input type="checkbox"/>	J3HRNTDS	E0960	Contoured-Dynamic Pull Down (Sml)	\$177.00
<input type="checkbox"/>	J3HRNCOM	E0960	Center Opening w/ Buckle (Med)	\$177.00	<input type="checkbox"/>	J3HRNTDM	E0960	Contoured-Dynamic Pull Down (Med)	\$177.00
<input type="checkbox"/>	J3HRNCOL	E0960	Center Opening w/ Buckle (Lrg)	\$177.00	<input type="checkbox"/>	J3HRNTDL	E0960	Contoured-Dynamic Pull Down (Lrg)	\$177.00
<input type="checkbox"/>	J3HRNCOX	E0960	Center Opening w/ Buckle (X-Lrg)	\$177.00	<input type="checkbox"/>	J3HRNTDX	E0960	Contoured-Dynamic Pull Down (X-Lrg)	\$177.00
<input type="checkbox"/>	J3HRNCDS	E0960	Classic-Dynamic Pull Down (Sml)	\$177.00	<input type="checkbox"/>	J3HRNTSS	E0960	Contoured-Structured Pull Down (Sml)	\$177.00
<input type="checkbox"/>	J3HRNCDM	E0960	Classic-Dynamic Pull Down (Med)	\$177.00	<input type="checkbox"/>	J3HRNTSM	E0960	Contoured-Structured Pull Down (Med)	\$177.00
<input type="checkbox"/>	J3HRNCDL	E0960	Classic-Dynamic Pull Down (Lrg)	\$177.00	<input type="checkbox"/>	J3HRNTSL	E0960	Contoured-Structured Pull Down (Lrg)	\$177.00
<input type="checkbox"/>	J3HRNCDX	E0960	Classic-Dynamic Pull Down (X-Lrg)	\$177.00	<input type="checkbox"/>	J3HRNTSX	E0960	Contoured-Structured Pull Down (X-Lrg)	\$177.00
<input type="checkbox"/>	J3HRNCSS	E0960	Classic-Structured Pull Down (Sml)	\$177.00	<input type="checkbox"/>	J3HRNPSS	E0960	Padded Anterior Trunk Straps (Sml)	\$165.00
<input type="checkbox"/>	J3HRNCSM	E0960	Classic-Structured Pull Down (Med)	\$177.00	<input type="checkbox"/>	J3HRNPSM	E0960	Padded Anterior Trunk Straps (Med)	\$165.00
<input type="checkbox"/>	J3HRNCSL	E0960	Classic-Structured Pull Down (Lrg)	\$177.00	<input type="checkbox"/>	J3HRNPSL	E0960	Padded Anterior Trunk Straps (Lrg)	\$165.00
<input type="checkbox"/>	J3HRNC SX	E0960	Classic-Structured Pull Down (X-Lrg)	\$177.00	<input type="checkbox"/>	J3HRNP SX	E0960	Padded Anterior Trunk Straps (X-Lrg)	\$165.00

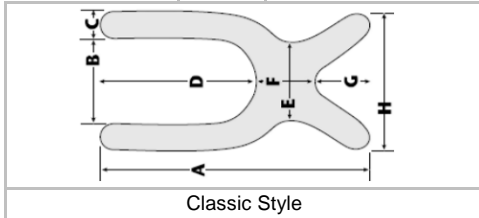

	A	B	C	D	E	F	G	H
S	15"	4.5"	2"	9"	4"	4"	2"	8.5"
M	19"	5.5"	2"	11"	5"	5"	3"	9.5"
L	22.5"	6.5"	2"	13"	6"	6"	3.5"	10.5"
XL	25.5"	6.5"	2.5"	14"	7"	7"	4.5"	11.5"

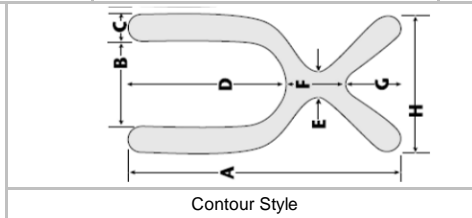

	A	B	C	D	E	F	G	H
S	15"	4.5"	2"	9"	1"	4"	2"	8.5"
M	18.5"	5.5"	2"	11"	1"	5"	2.5"	9.5"
L	22.5"	6.5"	2"	13"	1.5"	6"	3.5"	10.5"
XL	25.5"	6.5"	2.5"	14"	1.5"	7"	4.5"	11.5"

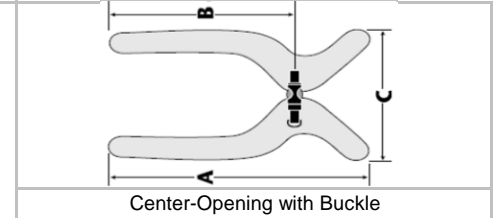

	A	B	C
S	12.3"	9"	6.5"
M	14.3"	11"	9.8"
L	15.5"	11.5"	9.8"
XL	17.5"	12.8"	10"

GUIDE BRACKETS & HARDWARE ONLY

<input type="checkbox"/>	J3GPSG	K0108	Shoulder Strap Guides	\$48.00	<input type="checkbox"/>	J3HHP	K0108	Hardware Pack Only	\$23.00
--------------------------	--------	-------	-----------------------	---------	--------------------------	-------	-------	--------------------	---------

VANITY FLAP

<input type="checkbox"/>	117096	K0108	12" to 14" Wide	\$52.00	<input type="checkbox"/>	117099	K0108	18" to 20" Wide	\$52.00
<input type="checkbox"/>	117097	K0108	14" to 16" Wide	\$52.00	<input type="checkbox"/>	117100	K0108	20" to 22" Wide	\$52.00
<input type="checkbox"/>	117098	K0108	16" to 18" Wide	\$52.00					

INNER COVER

To order a optional inner cover enter a additional line item by adding "IC" to the front of your desired J3 back part number and remove your hardware suffix.

<input type="checkbox"/>	Add "IC"	K0108	Inner Cover	\$147.00
--------------------------	----------	-------	-------------	----------

JAY YOUR WAY MODIFICATIONS

To order sizes offered via JAY Your Way add a "M" to the front of the part number and follow the prompts.

For additional modifications visit www.sunrisemedical.com.

PAINTED BACK SHELL

<input type="checkbox"/>	SBC	Painted Back Shell	NC
	Color:	<input type="checkbox"/> Match Quickie or Zippie Frame Color	

Note: Backshells can be painted any Quickie or Zippie Frame color at no charge please specify the desired color in the NOTES box below. For a full listing of frame colors available please visit www.sunrisemedical.com

MILITARY SERVICE PATCHES

<input type="checkbox"/>	VAPH	Purple Heart Service Patch	NC
<input type="checkbox"/>	VAM	Marine Service Patch	NC
<input type="checkbox"/>	VAA	Army Service Patch	NC
<input type="checkbox"/>	VAAF	Air Force Service Patch	NC
<input type="checkbox"/>	VAN	Navy Service Patch	NC
<input type="checkbox"/>	VACG	Coast Guard Service Patch	NC
<input type="checkbox"/>	VASF	US Space Force Service Patch	NC

EMBROIDERY

<input type="checkbox"/>	EMBROIDERY	K0108 Embroidery (32 Character Max)	\$26.00
--------------------------	------------	-------------------------------------	---------

Location: Front

Font: Block Script

Embroidery Text:

Embroidery Color:

SPINAL FLUID PAD

<input type="checkbox"/>	SFPS	Small Spinal Fluid Pad (16" Height)	\$58.00
<input type="checkbox"/>	SFPM	Medium Spinal Fluid Pad (18" Height)	\$58.00
<input type="checkbox"/>	SFPT	Tall Spinal Fluid Pad (20" Height)	\$58.00
<input type="checkbox"/>	SFPXT	Extra Tall Spinal Fluid Pad (23" Height)	\$58.00

VISCO FOAM INSERT

<input type="checkbox"/>	VF	Visco Foam Insert	\$58.00
<input type="checkbox"/>	VFWSR	Visco Foam Insert with Spinal Relief	\$58.00

Note: 2 Layers of 1" Yellow Visco foam is utilized as standard. Different colors of Visco foam can be utilized just list desired color in notes below.

Don't see the option you want? NO PROBLEM! Write your request below and we can evaluate it and provide a quote.

Notes:



Sunrise Medical (US) LLC

12002 Volunteer Blvd. · Mount Juliet, TN 37122 · USA

Customer Service: 800-333-4000 Fax: 800-300-7502 Email: orders@sunmed.com www.sunrisemedical.com

Sunrise Medical (US) LLC ©1/2025 MK-100141 REV. N