

Mark For: _____

Date: _____

Dealer Acct #: _____

Dealer: _____

Dealer Contact: _____

Dealer Address: _____

Dealer City: _____ ST: _____ ZIP: _____

Dealer Phone: () _____ Fax: () _____

Confirmation Email: _____

Confirm Via: Fax Email

Submitting for: Quote Order

PO#: _____

ADDITIONAL SHIPPING INFORMATION

Ship To: _____

Attention: _____

Address: _____

Address: _____

Ship To City: _____ ST: _____ ZIP: _____





Ship To Phone: () _____ Fax: () _____

The **HCPCS CODES** herein are based on PDAC verification or interpretation of Medicare definitions and guidelines. Non-Medicare payers may accept alternative **HCPCS CODES**, including misc. codes to ensure access for their enrollees. The use of **HCPCS CODES** does not ensure coverage or payment.

Head Positioning - Use HCPCS Code E0955



Whitmyer headrests come unassembled. Please add item WHITASSY001 if the dealer would like parts assembled. This is a no charge option.

Note: For cover selection, L = Lycra and V = Dartex Reversed (Example: AXYS-HUFALL or AXYS-HUFALV)

		 <input type="checkbox"/> Receiver must be selected on pg 2	 <input type="checkbox"/> Receiver must be selected on pg 2	 <input type="checkbox"/> Receiver must be selected on pg 2	 <input type="checkbox"/> Receiver must be selected on pg 2
PAD		AXYS	ONYX	LINX	LINX²
CONTOUR CRADLE	Large	<input type="checkbox"/> AXYS-CCS4L \$236	<input type="checkbox"/> ONYX-CCS4L \$236	<input type="checkbox"/> LINX-CCS4L \$183	<input type="checkbox"/> LINX2-CCS4L \$224
	Medium	<input type="checkbox"/> AXYS-CCS3L \$224	<input type="checkbox"/> ONYX-CCS3L \$224	<input type="checkbox"/> LINX-CCS3L \$171	<input type="checkbox"/> LINX2-CCS3L \$213
	Small	<input type="checkbox"/> AXYS-CCS2L \$213	<input type="checkbox"/> ONYX-CCS2L \$213	<input type="checkbox"/> LINX-CCS2L \$160	<input type="checkbox"/> LINX2-CCS2L \$199
C-PLUSH	Large	<input type="checkbox"/> AXYS-CCS4V \$236	<input type="checkbox"/> ONYX-CCS4V \$236	<input type="checkbox"/> LINX-CCS4V \$183	<input type="checkbox"/> LINX2-CCS4V \$224
	Medium	<input type="checkbox"/> AXYS-CCS3V \$224	<input type="checkbox"/> ONYX-CCS3V \$224	<input type="checkbox"/> LINX-CCS3V \$171	<input type="checkbox"/> LINX2-CCS3V \$213
	Small	<input type="checkbox"/> AXYS-CCS2V \$213	<input type="checkbox"/> ONYX-CCS2V \$213	<input type="checkbox"/> LINX-CCS2V \$160	<input type="checkbox"/> LINX2-CCS2V \$199
CONTOUR CRADLE INFANT		<input type="checkbox"/> AXYS-CCS1 \$213	<input type="checkbox"/> ONYX-CCS1 \$213	N/A	





Head Positioning - Use HCPCS Code E0955

Whitmyer headrests come unassembled. Please add item WHITASSY001 if the dealer would like parts assembled. This is a no charge option.

		 <input type="checkbox"/> Receiver must be selected on pg 2	 <input type="checkbox"/> Adult - 15" <input type="checkbox"/> Peds - 11" <input type="checkbox"/> EI - 10"	 <input type="checkbox"/> Adult - 15" <input type="checkbox"/> Peds - 11" <input type="checkbox"/> EI - 10"
PAD		PRO	COBRA	COBRA-FB
CONTOUR CRADLE	Large	<input type="checkbox"/> PRO-CCS4L \$271	<input type="checkbox"/> COBRA-CCS4L \$508	<input type="checkbox"/> FB-COBRA-CCS4L \$624
	Medium	<input type="checkbox"/> PRO-CCS3L \$271	<input type="checkbox"/> COBRA-CCS3L \$508	<input type="checkbox"/> FB-COBRA-CCS3L \$624
	Small	<input type="checkbox"/> PRO-CCS2L \$271	<input type="checkbox"/> COBRA-CCS2L \$508	<input type="checkbox"/> FB-COBRA-CCS2L \$624
C-PLUSH	Large	<input type="checkbox"/> PRO-CCS4V \$271	<input type="checkbox"/> COBRA-CCS4V \$508	<input type="checkbox"/> FB-COBRA-CCS4V \$624
	Medium	<input type="checkbox"/> PRO-CCS3V \$271	<input type="checkbox"/> COBRA-CCS3V \$508	<input type="checkbox"/> FB-COBRA-CCS3V \$624
	Small	<input type="checkbox"/> PRO-CCS2V \$271	<input type="checkbox"/> COBRA-CCS2V \$508	<input type="checkbox"/> FB-COBRA-CCS2V \$624
C-PLUSH	Large	<input type="checkbox"/> PRO-CCP4L \$271	<input type="checkbox"/> COBRA-CCP4L \$508	<input type="checkbox"/> FB-COBRA-CCP4L \$624
	Medium	<input type="checkbox"/> PRO-CCP3L \$271	<input type="checkbox"/> COBRA-CCP3L \$508	<input type="checkbox"/> FB-COBRA-CCP3L \$624
	Small	<input type="checkbox"/> PRO-CCP2L \$271	<input type="checkbox"/> COBRA-CCP2L \$508	<input type="checkbox"/> FB-COBRA-CCP2L \$624

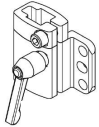



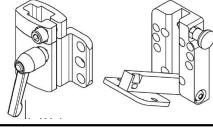
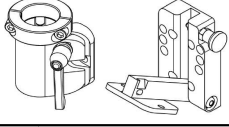
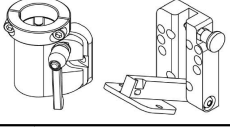
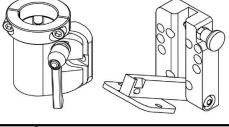



Mounting Brackets - Use HCPCS Code E1033

Head Support System Mounting Brackets must be ordered separately, except for COBRA



	AXYS	ONYX	LINX & LINX ²	PRO	COBRA mounting system includes detachable mounting bracket
REMOVABLE MOUNTING BRACKET (PART SOLD SEPARATELY FROM POST & PAD)					
Detachable	<input type="checkbox"/> M2500S \$124	<input type="checkbox"/> M2100-WBS \$101	<input type="checkbox"/> M2300S \$194	<input type="checkbox"/> M2200-WBS \$218	
REMOVABLE & SWING-AWAY MNT BRACKET (PART SOLD SEPARATELY FROM POST & PAD)					
Swing-Away	<input type="checkbox"/> M5500 \$236	<input type="checkbox"/> M5100 \$218	<input type="checkbox"/> M5300 \$312	<input type="checkbox"/> M5200 \$336	

Lateral Facial Supports

Note: Cover Selection - Add L = Lycra or V = Dartex Reversed (Example: LFC-PL L)

								
	2"	2.25" x 5"	2.25" x 7"	4" x 6"	2" x 6"	1.75" x 5"	1.25" x 4"	
	SPOT	STANDARD	LONG	OVAL	LARGE-C	MED-C	SMALL-C	FSO-8
Unilateral	<input type="checkbox"/> LFC10-CSL \$259 LM115S \$94	<input type="checkbox"/> LFC15-CSL \$259 LM115S \$94	<input type="checkbox"/> LFC20-CSL \$259 LM115S \$94	<input type="checkbox"/> LFC25-CSL \$259 LM115S \$94	<input type="checkbox"/> LFC30-CSL \$259 LM115S \$94	<input type="checkbox"/> LFC35-CSL \$259 LM115S \$94	<input type="checkbox"/> LFC40-CSL \$259 LM115S \$94	<input type="checkbox"/> LFC80-CS \$301 LM115S \$94
	<input type="checkbox"/> LFC10-CSV \$259 LM115S \$94	<input type="checkbox"/> LFC15-CSV \$259 LM115S \$94	<input type="checkbox"/> LFC20-CSV \$259 LM115S \$94	<input type="checkbox"/> LFC25-CSV \$259 LM115S \$94	<input type="checkbox"/> LFC30-CSV \$259 LM115S \$94	<input type="checkbox"/> LFC35-CSV \$259 LM115S \$94	<input type="checkbox"/> LFC40-CSV \$259 LM115S \$94	
Bilateral	<input type="checkbox"/> LFC10-CS2L \$483 LM115S \$94 LM115S \$94	<input type="checkbox"/> LFC15-CS2L \$483 LM115S \$94 LM115S \$94	<input type="checkbox"/> LFC20-CS2L \$483 LM115S \$94 LM115S \$94	<input type="checkbox"/> LFC25-CS2L \$483 LM115S \$94 LM115S \$94	<input type="checkbox"/> LFC30-CS2L \$483 LM115S \$94 LM115S \$94	<input type="checkbox"/> LFC35-CS2L \$483 LM115S \$94 LM115S \$94	<input type="checkbox"/> LFC40-CS2L \$483 LM115S \$94 LM115S \$94	<input type="checkbox"/> LFC80-CS2 \$552 LM115S \$94 LM115S \$94
	<input type="checkbox"/> LFC10-CS2V \$483 LM115S \$94 LM115S \$94	<input type="checkbox"/> LFC15-CS2V \$483 LM115S \$94 LM115S \$94	<input type="checkbox"/> LFC20-CS2V \$483 LM115S \$94 LM115S \$94	<input type="checkbox"/> LFC25-CS2V \$483 LM115S \$94 LM115S \$94	<input type="checkbox"/> LFC30-CS2V \$483 LM115S \$94 LM115S \$94	<input type="checkbox"/> LFC35-CS2V \$483 LM115S \$94 LM115S \$94	<input type="checkbox"/> LFC40-CS2V \$483 LM115S \$94 LM115S \$94	
Pad Only*	<input type="checkbox"/> PL10LS \$84 PL10VS \$84	<input type="checkbox"/> PL15LS \$118 PL15VS \$118	<input type="checkbox"/> PL20LS \$118 PL20VS \$118	<input type="checkbox"/> P600LS \$118 P600VS \$118	<input type="checkbox"/> PL30LS \$118 PL30VS \$118	<input type="checkbox"/> PL35LS \$118 PL35VS \$118	<input type="checkbox"/> PL40L \$106 PL40V \$106	N/A

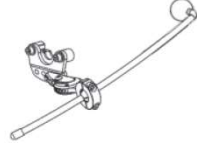
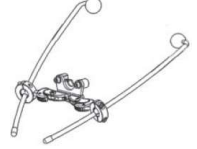
Lateral Facial Supports

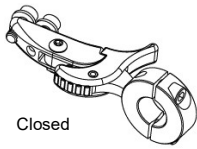

MOUNTING HARDWARE					
	Unilateral	Bilateral	Infinity Mount	Swing-Away Mount	LM115S

LATERAL FACIAL SUPPORT PARTS

*Note: If ordering an additional Lateral Facial Support, select both a Lateral Facial Support Pad Only from above and an Infinity Mount from below as well

✓	Option #	Definition	Price
<input type="checkbox"/>	242161	Infinity Dual Mount Assembly*	\$230
<input type="checkbox"/>	LM1010S	Lateral Facial Support*	\$148

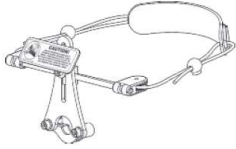
ANTERIOR HEAD SUPPORT

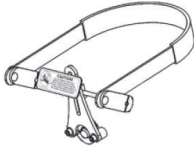
				
	DYNAMIC FOREHEAD STRAP	DFS²	STRAP CAP	STATIC FOREHEAD STRAP
ADULT	<input type="checkbox"/> DFS10 \$341	<input type="checkbox"/> DFSQ10S \$412	<input type="checkbox"/> CAP10 (black) \$471	<input type="checkbox"/> HU10 \$371
PEDS	<input type="checkbox"/> DFS30 \$341	<input type="checkbox"/> DFSQ30S \$412	<input type="checkbox"/> CAP30-R (red) \$471	
			<input type="checkbox"/> CAP30-B (blue) \$471	

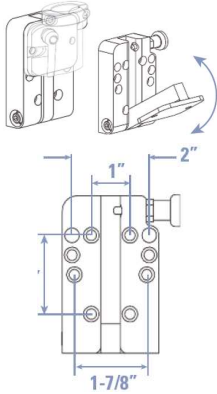
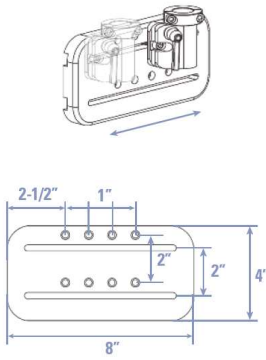
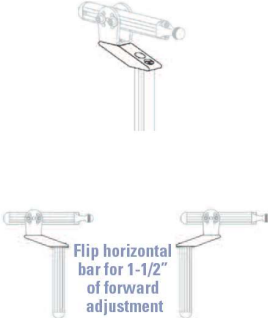
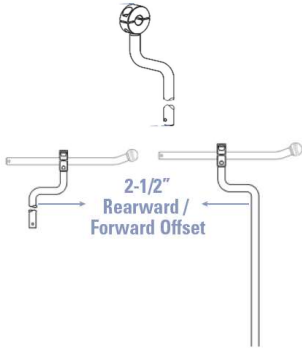

MOUNTING OPTIONS

				
FLEX INTERFACE BRACKET	UNIVERSAL SWING-AWAY MOUNT	SLIDE MOUNT	PRO OFF-SET MOUNTING SYSTEM	ONYX REARWARD OFF-SET VERTICAL ROD
<input type="checkbox"/> M9450S(hard) \$218 <input type="checkbox"/> M9451 (soft) \$218	<input type="checkbox"/> M5000S \$118	<input type="checkbox"/> M7010S \$112	<input type="checkbox"/> PRC7070 \$192	<input type="checkbox"/> OX6030 \$71

TOOLS

Option #	Definition	Price
<input type="checkbox"/> BOLT LUBE	Bolt Lube	\$10.00
<input type="checkbox"/> T2500S	Tool Kit	\$8.00

Pad Styles

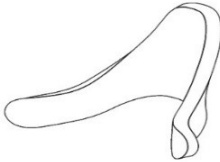
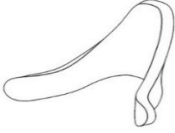
C-PLUSH	Large CCP4 7"w X 5"h		Medium CCP3 6"w X 4-1/2"h		Small CCP2 5"w X 4"h	
	CONTOUR CRADLE	Large CCS4 13"w X 7-1/2"h		Medium CCS3 10"w X 6-1/4"h		Small CCS2 8-1/2"w X 5-1/2"h

