

AI

ALUMINIUM 7020



CE

Customer Contact Details

Customer Name: _____

RGK Genius: _____

Address: _____

Phone: _____

Email: _____

Ship to Customer Address:

Shipping Name: _____

Shipping Address: _____

Phone: _____

Email: _____

Additional InformationNotes: _____

Current Wheelchair: _____

Customer Weight: _____

Customer Height: _____

Customer Disability: _____

Other**VAT Exemption Declaration (UK Only):**

I declare that I am chronically sick or disabled by reason of:

and that I am receiving from RGK Wheelchairs Ltd, the wheelchair specified herein and I claim relief from Value Added Tax under group 12 of schedule 8 to Value Added Tax Act 1994.

Signature: _____ Date: _____

RGK Contact Authorisation:

From time to time, RGK would like to send you exclusive information, news and offers on everything RGK, by email or post. We will not pass any of your details to any third party.

I would like to be contacted by RGK:

Signature: _____ Date: _____

SERIAL NO: _____

Guide:

- Base product
- Required option
- Optional Extra
- Critical Information
- Information Needed

PRODUCT STYLE

ECAXZ010 ELITE CX
\$8,544.00

- XA600 Heat treated frame
- ECAXA062 Standard
- ECAXA063 Standard with 25mm seatrail
\$80.00



Max User Weight 125kg (275lbs)

PLEASE NOTE: ALL RGK CHAIRS ARE HAND BUILT AND HAVE A MANUFACTURING MEASUREMENT TOLERANCE OF +/- 5MM

CAD APPROVAL

CAD approved by: Customer RGK Genius

XW009 QUOTE ONLY (NO CAD FOR APPROVAL)
\$0.00

XW011 ORDER (NO CAD FOR APPROVAL)
\$0.00

XW012 QUOTE CAD drawing for approval
\$483.00 (2 customer amendments ONLY)

XW010 ORDER CAD drawing for approval
\$278.00 (2 customer amendments ONLY)

KEY FRAME MEASUREMENTS

XY010 Seat width (*Inside to inside of sideguards*)
 mm in (Max - 390mm)
 (Min=270mm)

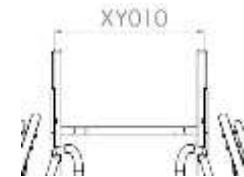

Select CX shell width (optional)

A-330mm	XY010 = 270-315	C-380mm	XY010 = 320-365
B-355mm	XY010 = 295-340	D-405mm	XY010 = 345-390

Note: CX Shell Seat Taper

Seat Taper	Seat length (mm)				
	250	300	350	400	
Seat width (mm)	330	305	280	255	230
	355	330	305	280	255
	380	355	330	305	280
	405	380	355	330	305

Hard foam will be used to get Seat width

XY020 Seat length
 mm in Std = 20mm less than seat upholstery
 (Max - 500mm)

XY030 Extra seat length (*Provides additional leg support & hand grip*)

mm in

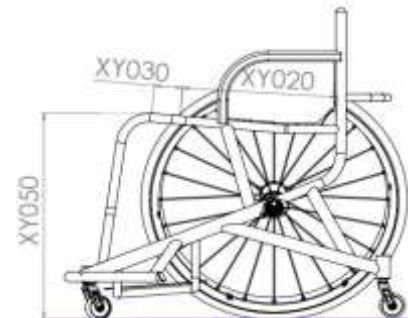

ECAXY050 Front seat height (*Floor to middle of seat without cushion*)
 mm in (Max - 630mm)
 (Min - 360mm)

ECAXY060 Rear seat height (*Floor to middle of seat without cushion*)
 mm in (Max - 630mm)
 (Min - 360mm)

XY070 Frame length
 mm in (Min = XY020 + XY030 + 140mm)

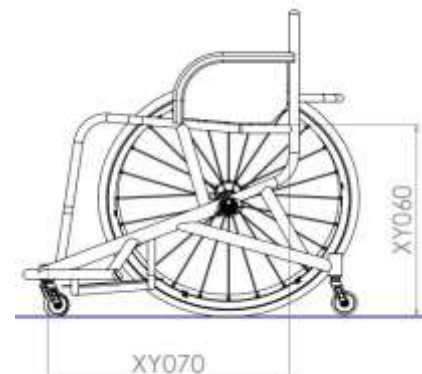

FRONT FRAME

XY080 Seat taper design



Specify taper width

mm in



FOOTREST

Footrest Type



ECAXB080 Fixed position footrest

5 Multi position footrest tubes

\$161.00



Footrest Measurements

Front footrest height

mm in

(min = 35mm)



Footrest width

mm in

(Std = 200mm)

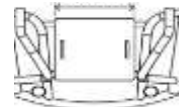

Rear footrest height

mm in

(min = 35mm)



Footrest length

mm in

(Std = 250mm)

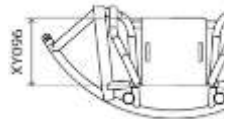

Footrest position

(front of footplate to castor pot)

mm in

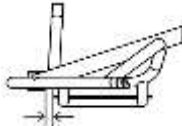

Footrest Plate

XB190 Carbon fibre footplate
\$265.00

XB100 ABS moulded foot tray
\$155.00

Specify length

ECAXB140 Spacer kit
\$22.00
(Allows for 25mm increase in height)



mm in Max = 380mm (Full)
Std = 330mm

Footrest Plate Options

XB240 Aluminium raised edges
\$91.00
(Cost per Edge)

XB250 Carbon Fibre raised edge
\$350.00
(1 side only)

Front Back Left Right

Front Back

Specify height

mm in

(Max = 60mm)

Specify height

mm in

(Max = 45mm)

Castor Pin Width



XY330 Castor pin width



mm in **MAX 320mm**

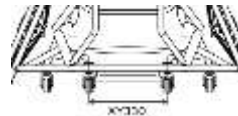

Optimise measurements

CAMBER BAR, WING AND ANTI-TIP

Centre of Gravity and Camber Angle

ECAXY510 Fixed centre of gravity



Specify measurement

mm in



XY390 Camber angle



18 20

Wing Options (Choose one)

ECAXA110 Round design basketball wing



ECAXA125 Arrow design basketball wing
\$201.00

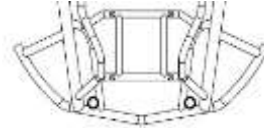

ECAXA120 Straight sided design basketball wing
\$201.00



Anti-tip options (Choose one)

ECAXJ040 Single fixed anti tip

ECAXJ060 Double fixed anti tip
\$285.00

CX SIDES

Side Measurements

Sideguard height
(std = 150mm)(follow tyre)(Max = 180)



mm in



Backrest depth
(std = 120mm)(Max = 150)



mm in

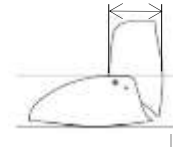

Individual Shape

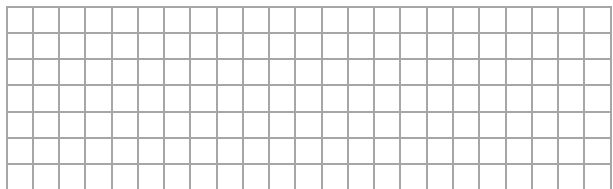
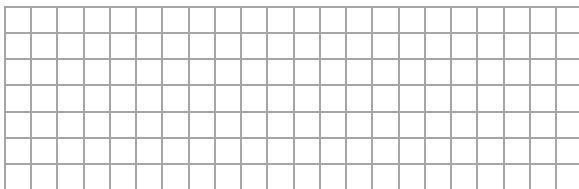

BACKREST

Backrest Height (Choose One)

XY230 Fixed backrest height



Specify height

mm in

Backrest depth **top**
(distance from front of back post to middle of upholstery)

mm in

Backrest depth **bottom**
(distance from front of back post to middle of upholstery)

mm in

Note: Take measurement from existing chair

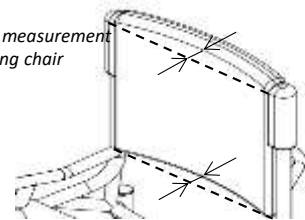

CASTOR AND REAR WHEELS

Castor Options

	XC160 Sport 61mm castor <i>(Black)</i>	XC181 Bones Reds bearings <i>(All castor bearings)</i>
	XC200 Sport micro fork	\$335.00 Bones Swiss Ceramic bearings <i>(All castor bearings)</i>

Rear Wheel Size

XY420 24" Wheels	XY430 25" Wheels	XY440 26" Wheels	XY450 700C Wheels
------------------	------------------	------------------	-------------------

Rear Wheel Gap

XY460 Rear wheel gap		XY470 Inside to inside of wheel	
15 20 25 30 Individual	OR		

Rear Wheel Options

XK080 Spinerger SLX 24 spoke \$902.00	XK330 Spinerger SLX R10 heavy duty 24 spoke \$1,589.00 (18 deg camber angle only)
XK101 Spinerger XSLX 24 spoke + Caps \$951.00	XK521 Spinerger Ceramic bearing upgrade \$289.00

Spinerger Colour Options:

Black spokes	White spokes	Yellow spokes	XK180 Individual spoke design \$212.00 <i>(Specify colour)</i>
Red spokes	Blue spokes	Pink spokes	<i>Inside:</i>
Purple spokes	Orange spokes	Green spokes	<i>Outside:</i>

Spinerger Anodise Options

XK190 Black hub <i>(std option)</i>	XK200 Silver hub \$111.00	XK201 Red hub/rims \$329.00	XK205 Individual hub/rims \$381.00 Select colour:
XK202 Purple hub/rims \$329.00	XK203 Blue hub/rims \$329.00	XK204 Gold hub/rims \$329.00	

Supply Without Wheels

XK040 Supply without Wheels -\$222.00	
---	--

Handrim Position / Options

XY480 Narrow set handrim	XY485 Wide set handrim
XL090 Remove excess mounting tabs \$122.00 <i>(recommended for small wheel gaps)</i>	XL080 Super narrow set handrim \$233.00 <i>(only with XL040 and includes XL090)</i>

Handrim Style

XL010 Aluminium hard anodised 6 tab	XL040 Titanium 6 tab \$290.00 (Not with 700C)
XL070 Aluminium hard anodised 12 tab \$111.00 (24" not available)	XL050 Stainless steel 6 tab \$152.00

Tyre Options

XM070 Kenda Kaliente	Red Blue	XM095 Kenda Wide \$43.00 <i>(Grey Only)</i>
XM150 IRC Exeracer Pro \$100.00 (Red Only)		
XM080 Tufo MS3 tubeless \$100.00 (Blue only)		

Spare Wheel

ECAXK500 Spare wheel Spinerger \$1,018.00 <i>(Built up + axle pin)</i>	XK523 Spare wheel upcharge - Individual Hubs/Rims \$147.00
XK520 Spare wheel upcharge - Titanium Rims \$237.00	XK524 Spare wheel upcharge - Individual Spoke Colour \$107.00
XK522 Spare wheel upcharge - Remove Excess Tabs \$63.00	

Inner Tube Valve Options

XY500 Schraeder inner tube valve		XY490 Presta inner tube valve (Standard if no option selected)	
----------------------------------	--	--	--

FINISH OPTIONS

Frame finish

XN010 Powder coated frame

Frame	Gloss	Frame	Matt	Frame	Special
					Chrome Mirror 300
	White gloss 100		White matt 101		Sparkle silver 170
					White sandpaper 200

XN200 Individual paint colour (State Colour/RAL code)
\$197.00

ECAXN030 Brushed frame
\$399.00

ECAXN050 Polished frame
\$1,054.00

Accent Colour

Note: Accent colour includes, forks, castor caps, and decals.



Black accent	Silver accent	XN250	Individual accent
Red accent	Blue accent	\$197.00	
Purple accent			

CUSHION

Cushion foam options



XP200 CX seat and backrest upholstery

Seat cushion foam thickness

7mm 10mm 25mm 50mm Individual thickness
mm in

Seat cushion foam type
Soft Med Plastazote (Hard)

Backrest foam thickness

7mm 10mm 25mm 50mm Individual thickness
mm in

Backrest foam type
Soft Med Plastazote (Hard)

Indicate Max Height:

580mm 630mm

STRAPPING

Velcro straps

- XS050 100mm Pro adjustable velcro strap
\$137.00
- XS055 50mm Pro adjustable velcro strap
\$137.00
- XS057 50mm Pro adjustable velcro **Knee** strap
\$137.00
(measurement from tube to tube over knees)

Velcro strap position

Strap 1

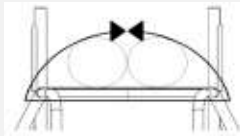

Specify strap length

mm in

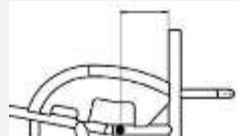

Specify distance from back post

mm in

Strap 2

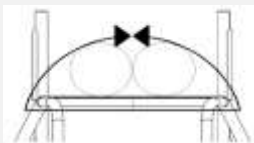

Specify strap length

mm in

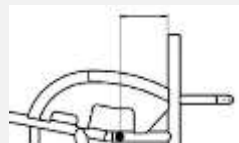

Specify distance from back post

mm in

Ratchet Straps

- XS020 Sport ratchet strap (Click strap)
(11" x 2" pad)
\$93.00
- XS021 Sport ratchet strap (Single)
\$93.00
- XS025 Pelvi Loc 2DA ratchet strap
(For thighs and knees)
\$243.00
Select size:
Medium (12") Large (14")
- XS030 Pelvi Loc 3DA ratchet strap
(For hips)
\$260.00
Select size:
S (8") M (12") L (14") XL (17")
- XS035 M2 ratchet strap
(For thighs and knees)
\$155.00
8" 10" 12"
- XS036 M2 ratchet strap (Single)
(For Feet)
\$155.00
8" 10" 12"

Ratchet strap position

Strap 1

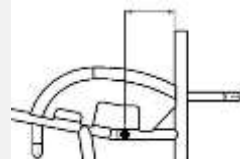

Specify distance from back post

mm in

Strap 2

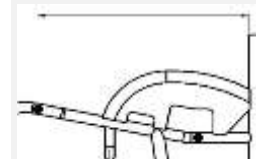

Specify distance from back post

mm in

- XS040 Fixed mounting points
(one set per click strap)
\$97.00 x1 x2 x3

FRAME OPTIONS

- XR060 Calf strap mounting loops
\$116.00



- XR065 Strap location loops
\$116.00



ACCESSORIES

- XR030 Triple wheel bag
(Black)
\$114.00
- XP130 Frame protectors full length
\$104.00
- XA150 Plastic tube fitted to offensive wing
\$74.00
- XS070 Foot strap (select if required)
- XS060 Calf strap (select if required)
- XP400 Back bar protector
- XR090 Tool kit

ADDITIONAL NOTES

OFF SPEC REQUEST* *(please specify below the page number(s) and details to which the off spec request applies.*

**OFF SPEC REQUEST
APPROVED** *(for internal
RGK office only)*

X
RGK Internal Sign-off

Off spec requests require a feasibility study which may increase order price and lead time. Any dimension/ option/ frame request not listed on the order form will be treated as an off spec request.*

Estimated MSRP*