

AI

ALUMINIUM 7020



CE

Customer Contact Details

Customer Name: _____

RGK Genius: _____

Address: _____

Phone: _____

Email: _____

Ship to Customer Address:

Shipping Name: _____

Shipping Address: _____

Phone: _____

Email: _____

Additional Information

Notes: _____

Current Wheelchair: _____

Customer Weight: _____

Customer Height: _____

Customer Disability: _____

Other**VAT Exemption Declaration (UK Only):**

I declare that I am chronically sick or disabled by reason of:

and that I am receiving from RGK Wheelchairs Ltd, the wheelchair specified herein and I claim relief from Value Added Tax under group 12 of schedule 8 to Value Added Tax Act 1994.

Signature: _____ Date: _____

RGK Contact Authorisation:

From time to time, RGK would like to send you exclusive information, news and offers on everything RGK, by email or post. We will not pass any of your details to any third party.

I would like to be contacted by RGK:

Signature: _____ Date: _____

Guide:

- Base product
- Required option
- Optional Extra
- Critical Information
- Information Needed

PRODUCT STYLE

ECAXZ010 ELITE CX
\$7,824.00

- XA600 Heat treated frame
- ECAXA062 Standard
- ECAXA063 Standard with 25mm seatrail
\$72.00



Max User Weight 125kg (275lbs)

PLEASE NOTE: ALL RGK CHAIRS ARE HAND BUILT AND HAVE A MANUFACTURING MEASUREMENT TOLERANCE OF +/- 5MM

CAD APPROVAL

CAD approved by: Customer RGK Genius

XW009 QUOTE ONLY (NO CAD FOR APPROVAL)
\$0.00

XW011 ORDER (NO CAD FOR APPROVAL)
\$0.00

XW012 QUOTE CAD drawing for approval
\$421.00 **(2 customer amendments ONLY)**

XW010 ORDER CAD drawing for approval
\$260.00 **(2 customer amendments ONLY)**

KEY FRAME MEASUREMENTS

XY010 Seat width (*Inside to inside of sideguards*)
 mm in (Max - 390mm)
(Min=270mm)

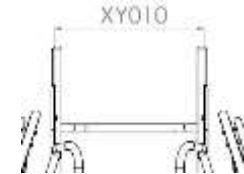

Select CX shell width (optional)

A-330mm XY010 = 270-315 C-380mm XY010 = 320-365
B-355mm XY010 = 295-340 D-405mm XY010 = 345-390

Note: CX Shell Seat Taper

Seat Taper	Seat length (mm)				
	250	300	350	400	
Seat width (mm)	330	305	280	255	230
	355	330	305	280	255
	380	355	330	305	280
	405	380	355	330	305

Hard foam will be used to get Seat width

XY020 Seat length
 mm in Std = 20mm less than seat upholstery
(Max - 500mm)

XY030 Extra seat length (*Provides additional leg support & hand grip*)

mm in

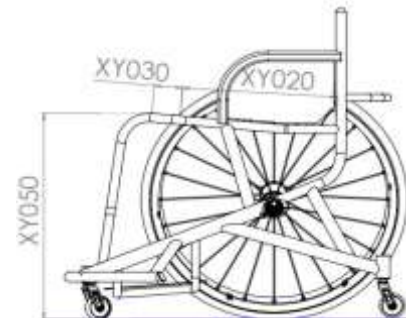

ECAXY050 Front seat height (*Floor to middle of seat without cushion*)
 mm in (Max - 630mm)
(Min - 360mm)

ECAXY060 Rear seat height (*Floor to middle of seat without cushion*)
 mm in (Max - 630mm)
(Min - 360mm)

XY070 Frame length
 mm in (Min = XY020 + XY030 + 140mm)



FRONT FRAME

XY080 Seat taper design



Specify taper width

mm in



FOOTREST

Footrest Type



ECAXB080 Fixed position footrest

ECAXB145 Multi position footrest tubes **\$147.00**



Footrest Measurements

Front footrest height

mm in

(min = 35mm)



Footrest width

mm in

(Std = 200mm)

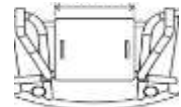

Rear footrest height

mm in

(min = 35mm)



Footrest length

mm in

(Std = 250mm)

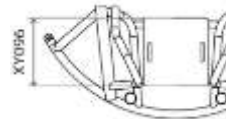

Footrest position

(front of footplate to castor pot)

mm in

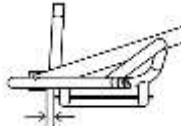

Footrest Plate

XB190 Carbon fibre footplate **\$230.00**

XB100 ABS moulded foot tray **\$135.00**

Specify length

ECAXB140 Spacer kit **\$19.00**
(Allows for 25mm increase in height)



mm in Max = 380mm (Full)
Std = 330mm

Footrest Plate Options

XB240 Aluminium raised edges **\$79.00**
(Cost per Edge)

XB250 Carbon Fibre raised edge **\$305.00**
(1 side only)

Front Back Left Right

Front Back

Specify height

mm in

(Max = 60mm)

Specify height

mm in

(Max = 45mm)

Castor Pin Width



XY330 Castor pin width



mm in **MAX 320mm**

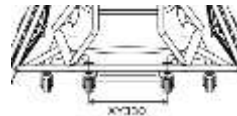

Optimise measurements

CAMBER BAR, WING AND ANTI-TIP

Centre of Gravity and Camber Angle

ECAXY510 Fixed centre of gravity



Specify measurement

mm in



XY390 Camber angle



18 20

Wing Options (Choose one)

ECAXA110 Round design basketball wing



ECAXA125 Arrow design basketball wing
\$185.00

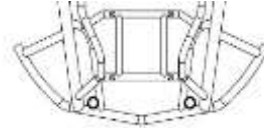

ECAXA120 Straight sided design basketball wing
\$185.00



Anti-tip options (Choose one)

ECAXJ040 Single fixed anti tip

ECAXJ060 Double fixed anti tip
\$261.00

CX SIDES

Side Measurements

Sideguard height
(std = 150mm)(follow tyre)(Max = 180)



mm in



Backrest depth
(std = 120mm)(Max = 150)



mm in

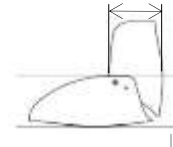

Individual Shape

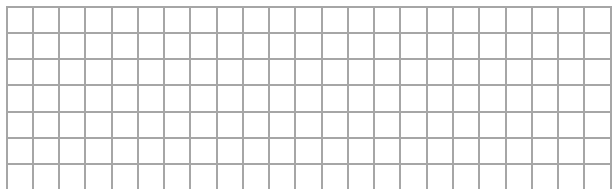
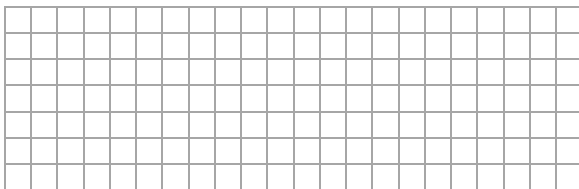

BACKREST

Backrest Height (Choose One)

XY230 Fixed backrest height



Specify height

mm in

Backrest depth **top**
(distance from front of back post to middle of upholstery)

mm in

Backrest depth **bottom**
(distance from front of back post to middle of upholstery)

mm in

Note: Take measurement from existing chair

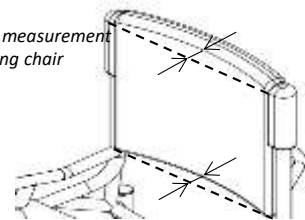

CASTOR AND REAR WHEELS								
Castor Options								
	XC160	Sport 61mm castor <i>(Black)</i>			XC181	Bones Reds bearings <i>(All castor bearings)</i>		
	XC200	Sport micro fork			XC182	Bones Swiss Ceramic bearings <i>(All castor bearings)</i>		
					\$292.00			
Rear Wheel Size								
XY420	24" Wheels		XY430	25" Wheels		XY440	26" Wheels	
						XY450	700C Wheels	
Rear Wheel Gap								
XY460	Rear wheel gap			OR	XY470	Inside to inside of wheel		
	15	20	25					
<i>Individual</i>								
Rear Wheel Options								
XK080	Spinergy SLX 24 spoke				XK330	Spinergy SLX R10 heavy duty 24 spoke (18 deg camber angle only)		
\$787.00					\$1,454.00			
XK101	Spinergy XSLX 24 spoke + Caps				XK521	Spinergy Ceramic bearing upgrade		
\$863.00					\$264.00			
Spinergy Colour Options:								
Black spokes	White spokes	Yellow spokes			XK180	Individual spoke design <i>(Specify colour)</i>		
Red spokes	Blue spokes	Pink spokes			\$184.00			
Purple spokes	Orange spokes	Green spokes					<i>Inside:</i>	
							<i>Outside:</i>	
Spinergy Anodise Options								
XK190	Black hub <i>(std option)</i>	XK200	Silver hub	XK201	Red hub/rims	XK205	Individual hub/rims Select colour:	
		\$96.00		\$287.00		\$332.00		
XK202	Purple hub/rims	XK203	Blue hub/rims	XK204	Gold hub/rims			
\$287.00		\$287.00		\$287.00				
Supply Without Wheels								
XK040	Supply without Wheels							
-\$184.00								
Handrim Position / Options								
XY480	Narrow set handrim				XY485	Wide set handrim		
XL090	Remove excess mounting tabs <i>(recommended for small wheel gaps)</i>				XL080	Super narrow set handrim <i>(only with XL040 and includes XL090)</i>		
\$106.00					\$213.00			
Handrim Style								
XL010	Aluminium hard anodised 6 tab				XL040	Titanium 6 tab (Not with 700C)		
XL070	Aluminium hard anodised 12 tab (24" not available)				XL050	Stainless steel 6 tab		
\$106.00					\$252.00		\$139.00	
Tyre Options								
XM070	Kenda Kaliente	Red	Blue		XM095	Kenda Wide <i>(Grey Only)</i>		
					\$37.00			
XM150	IRC Exeracer Pro (Red Only)							
\$87.00								
XM080	Tufo MS3 tubeless (Blue only)							
\$87.00								
Spare Wheel								
ECAXK500	Spare wheel Spinergy <i>(Built up + axle pin)</i>				XK523	Spare wheel upcharge - Individual Hubs/Rims		
\$887.00					\$128.00			
XK520	Spare wheel upcharge - Titanium Rims				XK524	Spare wheel upcharge - Individual Spoke Colour		
\$206.00					\$92.00			
XK522	Spare wheel upcharge - Remove Excess Tabs							
\$54.00								
Inner Tube Valve Options								
XY500	Schraeder inner tube valve				XY490	Presta inner tube valve (Standard if no option selected)		

FINISH OPTIONS

Frame finish

XN010 Powder coated frame

Frame

Gloss

Black gloss 103

White gloss 100

Grey gloss 132

Cream gloss 135

Red gloss 108

Yellow gloss 120

Forest green gloss 143

Green gloss 107

Dark blue gloss 151

Royal blue gloss 154

Blue gloss 174

Duckegg blue gloss 141

Pink gloss 188

Orange gloss 180

Purple gloss 157

Frame

Matt

Black matt 105

White matt 101

Grey matt 131

Light grey matt 133

Navy blue matt 152

Frame

Special

Chrome Mirror 300

Sparkle silver 170

Metallic black matt 104

Metallic grey matt 130

Black sandpaper 201

Grey sandpaper 202

White sandpaper 200

XN200 Individual paint colour (State Colour/RAL code)
\$180.00

ECAXN030 Brushed frame
\$365.00

ECAXN050 Polished frame
\$965.00

Accent Colour

Note: Accent colour includes, forks, castor caps, and decals.



Black accent

Red accent

Purple accent

Silver accent

Blue accent

XN250
\$180.00

Individual accent

CUSHION

Cushion foam options



XP200 CX seat and backrest upholstery

Seat cushion foam thickness

7mm 10mm 25mm 50mm Individual thickness
mm in

Seat cushion foam type
Soft Med Plastazote (Hard)

Backrest foam thickness

7mm 10mm 25mm 50mm Individual thickness
mm in

Backrest foam type
Soft Med Plastazote (Hard)

Indicate Max Height:

580mm 630mm

STRAPPING

Velcro straps

- XS050 100mm Pro adjustable velcro strap
\$125.00
- XS055 50mm Pro adjustable velcro strap
\$125.00
- XS057 50mm Pro adjustable velcro **Knee** strap
\$125.00 (measurement from tube to tube over knees)

Velcro strap position

Strap 1

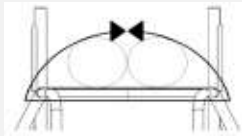

Specify strap length

mm in

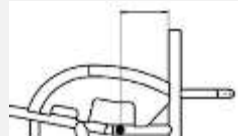

Specify distance from back post

mm in

Strap 2

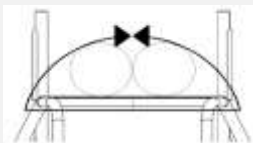

Specify strap length

mm in

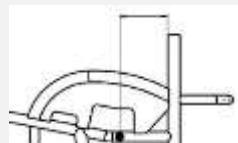

Specify distance from back post

mm in

Ratchet Straps

- XS020 Sport ratchet strap (Click strap) (11" x 2" pad)
\$85.00
- XS021 Sport ratchet strap (Single)
\$86.00
- XS025 Pelvi Loc 2DA ratchet strap (For thighs and knees)
\$222.00
Select size:
Medium (12") Large (14")
- XS030 Pelvi Loc 3DA ratchet strap (For hips)
\$238.00
Select size:
S (8") M (12") L (14") XL (17")
- XS035 M2 ratchet strap (For thighs and knees)
\$142.00
8" 10" 12"
- XS036 M2 ratchet strap (Single) (For Feet)
\$142.00
8" 10" 12"

Ratchet strap position

Strap 1

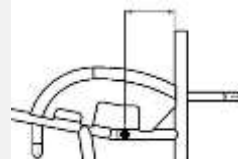

Specify distance from back post

mm in

Strap 2

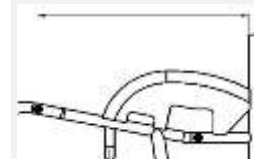

Specify distance from back post

mm in

- XS040 Fixed mounting points (one set per click strap)
\$89.00 x1 x2 x3

FRAME OPTIONS

- XR060 Calf strap mounting loops
\$106.00



- XR065 Strap location loops
\$106.00



ACCESSORIES

- XR030 Triple wheel bag (Black)
\$104.00
- XP130 Frame protectors full length
\$95.00
- XA150 Plastic tube fitted to offensive wing
\$68.00
- XS070 Foot strap (select if required)
- XS060 Calf strap (select if required)
- XP400 Back bar protector
- XR090 Tool kit

ADDITIONAL NOTES

OFF SPEC REQUEST* *(please specify below the page number(s) and details to which the off spec request applies.*

**OFF SPEC REQUEST
APPROVED** *(for internal
RGK office only)*

X
RGK Internal Sign-off

Off spec requests require a feasibility study which may increase order price and lead time. Any dimension/ option/ frame request not listed on the order form will be treated as an off spec request.*

Estimated MSRP*