

Mark For: _____

Submitting for: Quote Order

Date: _____

PO#: _____

Dealer Acct #: _____

Dealer: _____

Dealer Contact: _____

Dealer Address: _____

Dealer City: _____ ST: _____ ZIP: _____

Dealer Phone: () Fax: ()

Confirmation Email: _____

Confirm Via: Fax Email

ADDITIONAL SHIPPING INFORMATION

Ship To: _____

Attention: _____

Address: _____

Address: _____

Ship To City: _____ ST: _____ ZIP: _____

Ship To Phone: () Fax: ()

The **HCPCS CODES** herein are based on PDAC verification or interpretation of Medicare definitions and guidelines. Non-Medicare payers may accept alternative **HCPCS CODES**, including misc. codes to ensure access for their enrollees. The use of **HCPCS CODES** does not ensure coverage or payment.

Head Positioning - Use HCPCS Code E0955

Whitmyer headrests come unassembled. Please add item WHITASSY001 if the dealer would like parts assembled. This is a no charge option.

Note: For cover selection, L = Lycra and V = Dartex Reversed (Example: AXYS-HUFALL or AXYS-HUFALV)

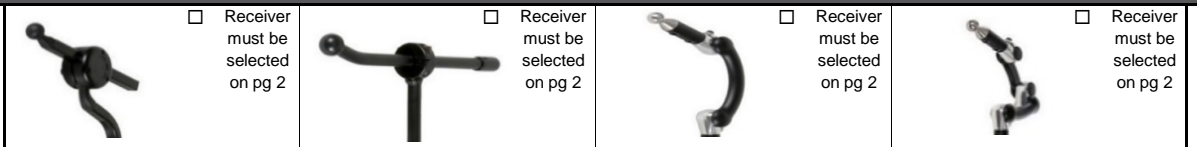

PAD			AXYS		ONYX		LINX		LINX ²	
HEADS UP - COMMON SIZES	Fixed Arm	Large	<input type="checkbox"/>	AXYS-HUFALL \$347	<input type="checkbox"/>	ONYX-HUFALL \$347	<input type="checkbox"/>	LINX-HUFALL \$347	<input type="checkbox"/>	LINX2-HUFALL \$390
			<input type="checkbox"/>	AXYS-HUFALV \$347	<input type="checkbox"/>	ONYX-HUFALV \$347	<input type="checkbox"/>	LINX-HUFALV \$347	<input type="checkbox"/>	LINX2-HUFALV \$390
		Medium	<input type="checkbox"/>	AXYS-HUFAML \$347	<input type="checkbox"/>	ONYX-HUFAML \$347	<input type="checkbox"/>	LINX-HUFAML \$347	<input type="checkbox"/>	LINX2-HUFAML \$390
			<input type="checkbox"/>	AXYS-HUFAMV \$347	<input type="checkbox"/>	ONYX-HUFAMV \$347	<input type="checkbox"/>	LINX-HUFAMV \$347	<input type="checkbox"/>	LINX2-HUFAMV \$390
		Small	<input type="checkbox"/>	AXYS-HUFASL \$347	<input type="checkbox"/>	ONYX-HUFASL \$347	<input type="checkbox"/>	LINX-HUFASL \$347	<input type="checkbox"/>	LINX2-HUFASL \$390
			<input type="checkbox"/>	AXYS-HUFASV \$347	<input type="checkbox"/>	ONYX-HUFASV \$347	<input type="checkbox"/>	LINX-HUFASV \$347	<input type="checkbox"/>	LINX2-HUFASV \$390
	Swing-Away Arms*	Early Intervention	<input type="checkbox"/>	AXYS-HUFAEIL \$347	<input type="checkbox"/>	ONYX-HUFAEIL \$347	<input type="checkbox"/>	LINX-HUFAEIL \$347	<input type="checkbox"/>	LINX2-HUFAEIL \$390
			<input type="checkbox"/>	AXYS-HUFAEIV \$347	<input type="checkbox"/>	ONYX-HUFAEIV \$347	<input type="checkbox"/>	LINX-HUFAEIV \$347	<input type="checkbox"/>	LINX2-HUFAEIV \$390
		Large	<input type="checkbox"/>	AXYS-HUSALL \$418	<input type="checkbox"/>	ONYX-HUSALL \$418	<input type="checkbox"/>	LINX-HUSALL \$418	<input type="checkbox"/>	LINX2-HUSALL \$460
			<input type="checkbox"/>	AXYS-HUSALV \$418	<input type="checkbox"/>	ONYX-HUSALV \$418	<input type="checkbox"/>	LINX-HUSALV \$418	<input type="checkbox"/>	LINX2-HUSALV \$460
		Medium	<input type="checkbox"/>	AXYS-HUSAML \$418	<input type="checkbox"/>	ONYX-HUSAML \$418	<input type="checkbox"/>	LINX-HUSAML \$418	<input type="checkbox"/>	LINX2-HUSAML \$460
			<input type="checkbox"/>	AXYS-HUSAMV \$418	<input type="checkbox"/>	ONYX-HUSAMV \$418	<input type="checkbox"/>	LINX-HUSAMV \$418	<input type="checkbox"/>	LINX2-HUSAMV \$460
Swing-Away Arms*	Small	<input type="checkbox"/>	AXYS-HUSASL \$418	<input type="checkbox"/>	ONYX-HUSASL \$418	<input type="checkbox"/>	LINX-HUSASL \$418	<input type="checkbox"/>	LINX2-HUSASL \$460	
		<input type="checkbox"/>	AXYS-HUSASV \$418	<input type="checkbox"/>	ONYX-HUSASV \$418	<input type="checkbox"/>	LINX-HUSASV \$418	<input type="checkbox"/>	LINX2-HUSASV \$460	
	Early Intervention	<input type="checkbox"/>	AXYS-HUSAEIL \$418	<input type="checkbox"/>	ONYX-HUSAEIL \$418	<input type="checkbox"/>	LINX-HUSAEIL \$418	<input type="checkbox"/>	LINX2-HUSAEIL \$460	
		<input type="checkbox"/>	AXYS-HUSAEIV \$418	<input type="checkbox"/>	ONYX-HUSAEIV \$418	<input type="checkbox"/>	LINX-HUSAEIV \$418	<input type="checkbox"/>	LINX2-HUSAEIV \$460	

Head Positioning - Use HCPCS Code E0955

Whitmyer headrests come unassembled. Please add item WHITASSY001 if the dealer would like parts assembled. This is a no charge option.

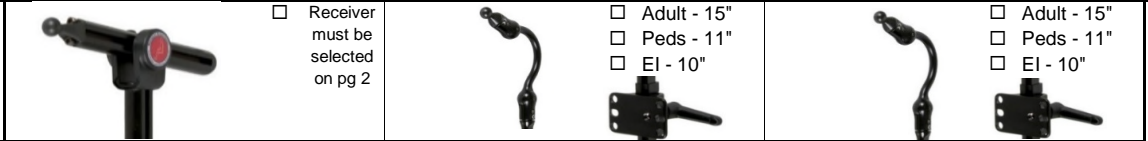





PAD			PRO		COBRA		COBRA-FB	
HEADS UP - COMMON SIZES	Fixed Arm	Large	<input type="checkbox"/>	PRO-HUFALL \$390	<input type="checkbox"/>	COBRA-HUFALL \$624	<input type="checkbox"/>	FBCOB-HUFALL \$744
			<input type="checkbox"/>	PRO-HUFALV \$390	<input type="checkbox"/>	COBRA-HUFALV \$624	<input type="checkbox"/>	FBCOB-HUFALV \$744
		Medium	<input type="checkbox"/>	PRO-HUFAML \$390	<input type="checkbox"/>	COBRA-HUFAML \$624	<input type="checkbox"/>	FBCOB-HUFAML \$744
			<input type="checkbox"/>	PRO-HUFAMV \$390	<input type="checkbox"/>	COBRA-HUFAMV \$624	<input type="checkbox"/>	FBCOB-HUFAMV \$744
		Small	<input type="checkbox"/>	PRO-HUFASL \$390	<input type="checkbox"/>	COBRA-HUFASL \$624	<input type="checkbox"/>	FBCOB-HUFASL \$744
			<input type="checkbox"/>	PRO-HUFASV \$390	<input type="checkbox"/>	COBRA-HUFASV \$624	<input type="checkbox"/>	FBCOB-HUFASV \$744
	Swing-Away Arms*	Early Intervention	<input type="checkbox"/>	PRO-HUFAEIL \$390	<input type="checkbox"/>	COBRA-HUFAEIL \$624	<input type="checkbox"/>	FBCOB-HUFAEIL \$744
			<input type="checkbox"/>	PRO-HUFAEIV \$390	<input type="checkbox"/>	COBRA-HUFAEIV \$624	<input type="checkbox"/>	FBCOB-HUFAEIV \$744
		Large	<input type="checkbox"/>	PRO-HUSALL \$471	<input type="checkbox"/>	COBRA-HUSALL \$707	<input type="checkbox"/>	FBCOB-HUSALL \$825
			<input type="checkbox"/>	PRO-HUSALV \$471	<input type="checkbox"/>	COBRA-HUSALV \$707	<input type="checkbox"/>	FBCOB-HUSALV \$825
		Medium	<input type="checkbox"/>	PRO-HUSAML \$471	<input type="checkbox"/>	COBRA-HUSAML \$707	<input type="checkbox"/>	FBCOB-HUSAML \$825
			<input type="checkbox"/>	PRO-HUSAMV \$471	<input type="checkbox"/>	COBRA-HUSAMV \$707	<input type="checkbox"/>	FBCOB-HUSAMV \$825
Swing-Away Arms*	Small	<input type="checkbox"/>	PRO-HUSASL \$471	<input type="checkbox"/>	COBRA-HUSASL \$707	<input type="checkbox"/>	FBCOB-HUSASL \$825	
		<input type="checkbox"/>	PRO-HUSASV \$471	<input type="checkbox"/>	COBRA-HUSASV \$707	<input type="checkbox"/>	FBCOB-HUSASV \$825	
	Early Intervention	<input type="checkbox"/>	PRO-HUSAEIL \$471	<input type="checkbox"/>	COBRA-HUSAEIL \$707	<input type="checkbox"/>	FBCOB-HUSAEIL \$825	
		<input type="checkbox"/>	PRO-HUSAEIV \$471	<input type="checkbox"/>	COBRA-HUSAEIV \$707	<input type="checkbox"/>	FBCOB-HUSAEIV \$825	

*See Page 2 for all configurations available

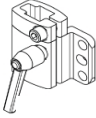
Mounting Brackets - Use HCPCS Code E1028

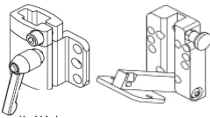
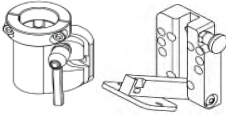
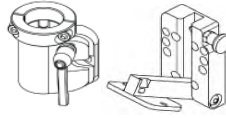
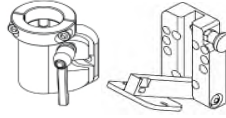

Head Support System Mounting Brackets must be ordered separately, except for COBRA

	AXYS	ONYX	LINX & LINX ²	PRO	COBRA mounting system includes detachable mounting bracket
REMOVABLE MOUNTING BRACKET (PART SOLD SEPARATELY FROM POST & PAD)					
Detachable	<input type="checkbox"/> M2500S \$124	<input type="checkbox"/> M2100-WBS \$101	<input type="checkbox"/> M2300S \$194	<input type="checkbox"/> M2200-WBS \$218	
REMOVABLE & SWING-AWAY MNT BRACKET (PART SOLD SEPARATELY FROM POST & PAD)					
Swing-Away	<input type="checkbox"/> M5500 \$236	<input type="checkbox"/> M5100 \$218	<input type="checkbox"/> M5300 \$312	<input type="checkbox"/> M5200 \$336	

HEADS UP - HEAD AND NECK POSITIONING SYSTEM ORDERING GUIDE

Head Support System Mounting Brackets must be ordered separately, except for COBRA

STEP 1: SELECT HARDWARE SYSTEM

							
	<input type="checkbox"/> AXYS-HU-	<input type="checkbox"/> ONYX-HU-	<input type="checkbox"/> LINX-HU-	<input type="checkbox"/> LINX2-HU-	<input type="checkbox"/> PRO-HU-	<input type="checkbox"/> COBRA-HU-	<input type="checkbox"/> FBCOB-HU-
W/O OCC Pad	\$418	\$418	\$418	\$460	\$471	\$707	\$825
W/ OCC Pad	\$536	\$536	\$536	\$577	\$590	\$825	\$944

BUILD YOUR HEADS UP SMART PART NUMBER

STEP 1 Enter Hardware System Part Number	
STEP 2 Enter I, S, M, or L	
STEP 3 Enter T or S	
STEP 4 Enter S or L	
STEP 5 Enter S or C	
STEP 6 Enter L or V	
STEP 7 (Optional) Enter -O5, -O6, -O8, or -O10	

STEP 2: SELECT NECK WIDTH



<input type="checkbox"/> I = Infant 3.3" wide
<input type="checkbox"/> S = Small 4" wide
<input type="checkbox"/> M = Medium 4.6" wide
<input type="checkbox"/> L = Large 5.8" wide

STEP 4: SELECT SWING OUT SUPPORT ARM LENGTH



<input type="checkbox"/> S = Short
<input type="checkbox"/> L = Long
<i>Infant & Small: Short = 5.63" Long = 7.25"</i>
<i>Medium & Large: Short = 7" Long = 9"</i>

STEP 5: SELECT FOAM TYPE

<input type="checkbox"/> S = Standard
<input type="checkbox"/> C = Comfort

STEP 6: SELECT COVER

<input type="checkbox"/> L = Lycra Neoprene
<input type="checkbox"/> V = Dartex Reversed

STEP 7: SELECT OPTIONAL OCC PADS

Available on Short Heights Only

<input type="checkbox"/> -O5 = Pediatric 5" Pad (Short Infant Sizes)
<input type="checkbox"/> -O6 = Adult 6" Pad (Short Small Sizes)
<input type="checkbox"/> -O8 = Plush 8" Pad (Short Medium Sizes)
<input type="checkbox"/> -O10 = Plush 10" Pad (Short Large Sizes)
<input type="checkbox"/> N/A

STEP 3: SELECT CONTOUR CRADLE HEIGHT

Tall











Short
shown with Occipital Pad (Step 7)





<input type="checkbox"/> T = Tall
<input type="checkbox"/> S = Short

Lateral Facial Supports

Note: Cover Selection - Add L = Lycra or V = Dartex Reversed (Example: LFC-PLL)

								
	2"	2.25" x 5"	2.25" x 7"	4" x 6"	2" x 6"	1.75" x 5"	1.25" x 4"	
	SPOT	STANDARD	LONG	OVAL	LARGE-C	MED-C	SMALL-C	FSO-8
Unilateral	<input type="checkbox"/> LFC10-CSL \$259 LM115S \$94	<input type="checkbox"/> LFC15-CSL \$259 LM115S \$94	<input type="checkbox"/> LFC20-CSL \$259 LM115S \$94	<input type="checkbox"/> LFC25-CSL \$259 LM115S \$94	<input type="checkbox"/> LFC30-CSL \$259 LM115S \$94	<input type="checkbox"/> LFC35-CSL \$259 LM115S \$94	<input type="checkbox"/> LFC40-CSL \$259 LM115S \$94	<input type="checkbox"/> LFC80-CS \$301 LM115S \$94
	<input type="checkbox"/> LFC10-CSV \$259 LM115S \$94	<input type="checkbox"/> LFC15-CSV \$259 LM115S \$94	<input type="checkbox"/> LFC20-CSV \$259 LM115S \$94	<input type="checkbox"/> LFC25-CSV \$259 LM115S \$94	<input type="checkbox"/> LFC30-CSV \$259 LM115S \$94	<input type="checkbox"/> LFC35-CSV \$259 LM115S \$94	<input type="checkbox"/> LFC40-CSV \$259 LM115S \$94	
Bilateral	<input type="checkbox"/> LFC10-CS2L \$483 LM115S \$94 LM115S \$94	<input type="checkbox"/> LFC15-CS2L \$483 LM115S \$94 LM115S \$94	<input type="checkbox"/> LFC20-CS2L \$483 LM115S \$94 LM115S \$94	<input type="checkbox"/> LFC25-CS2L \$483 LM115S \$94 LM115S \$94	<input type="checkbox"/> LFC30-CS2L \$483 LM115S \$94 LM115S \$94	<input type="checkbox"/> LFC35-CS2L \$483 LM115S \$94 LM115S \$94	<input type="checkbox"/> LFC40-CS2L \$483 LM115S \$94 LM115S \$94	<input type="checkbox"/> LFC80-CS2 \$552 LM115S \$94 LM115S \$94
	<input type="checkbox"/> LFC10-CS2V \$483 LM115S \$94 LM115S \$94	<input type="checkbox"/> LFC15-CS2V \$483 LM115S \$94 LM115S \$94	<input type="checkbox"/> LFC20-CS2V \$483 LM115S \$94 LM115S \$94	<input type="checkbox"/> LFC25-CS2V \$483 LM115S \$94 LM115S \$94	<input type="checkbox"/> LFC30-CS2V \$483 LM115S \$94 LM115S \$94	<input type="checkbox"/> LFC35-CS2V \$483 LM115S \$94 LM115S \$94	<input type="checkbox"/> LFC40-CS2V \$483 LM115S \$94 LM115S \$94	
Pad Only*	<input type="checkbox"/> PL10LS \$84	<input type="checkbox"/> PL15LS \$118	<input type="checkbox"/> PL20LS \$118	<input type="checkbox"/> P600LS \$118	<input type="checkbox"/> PL30LS \$118	<input type="checkbox"/> PL35LS \$118	<input type="checkbox"/> PL40L \$106	N/A
	<input type="checkbox"/> PL10VS \$84	<input type="checkbox"/> PL15VS \$118	<input type="checkbox"/> PL20VS \$118	<input type="checkbox"/> P600VS \$118	<input type="checkbox"/> PL30VS \$118	<input type="checkbox"/> PL35VS \$118	<input type="checkbox"/> PL40V \$106	

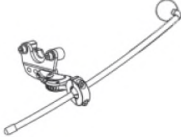
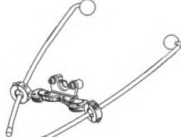
Lateral Facial Supports

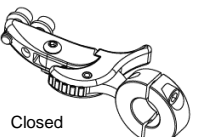

MOUNTING HARDWARE					
	Unilateral	Bilateral	Infinity Mount	Swing-Away Mount	
					LM115S

LATERAL FACIAL SUPPORT PARTS

*Note: If ordering an additional Lateral Facial Support, select both a Lateral Facial Support Pad Only from page 3 and an Infinity Mount from below as well

✓	Option #	Definition	Price
<input type="checkbox"/>	242161	Infinity Dual Mount Assembly*	\$230
<input type="checkbox"/>	LM1010S	Lateral Facial Support*	\$148

ANTERIOR HEAD SUPPORT

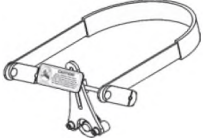
				
	DYNAMIC FOREHEAD STRAP	DFS ²	STRAP CAP	STATIC FOREHEAD STRAP
ADULT	<input type="checkbox"/> DFS10 \$341	<input type="checkbox"/> DFSQ10S \$412	<input type="checkbox"/> CAP10 (black) \$471	<input type="checkbox"/> HU10 \$371
PEDS	<input type="checkbox"/> DFS30 \$341	<input type="checkbox"/> DFSQ30S \$412	<input type="checkbox"/> CAP30-R (red) \$471	
			<input type="checkbox"/> CAP30-B (blue) \$471	

MOUNTING OPTIONS

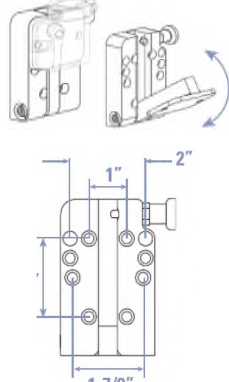
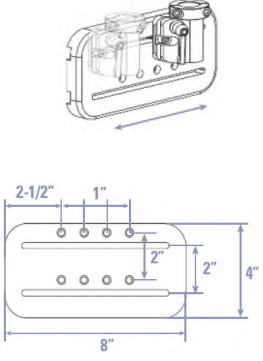
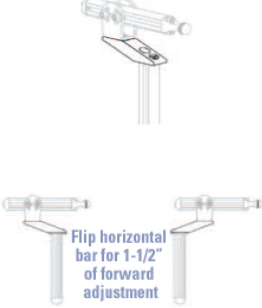
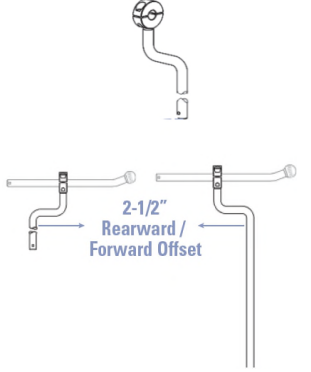
				
<p>FLEX INTERFACE BRACKET</p>	<p>UNIVERSAL SWING-AWAY MOUNT</p>	<p>SLIDE MOUNT</p>	<p>PRO OFF-SET MOUNTING SYSTEM</p>	<p>ONYX REARWARD OFF-SET VERTICAL ROD</p>

<input type="checkbox"/>	M9450S (hard)	\$218	<input type="checkbox"/>	M5000S	\$118	<input type="checkbox"/>	M7010S	\$112	<input type="checkbox"/>	PRC7070	\$192	<input type="checkbox"/>	OX6030	\$71
<input type="checkbox"/>	M9451 (soft)	\$218												

TOOLS

✓	Option #	Definition	Price
<input type="checkbox"/>	BOLT LUBE	Bolt Lube	\$10.00
<input type="checkbox"/>	T2500S	Tool Kit	\$8.00

Pad Styles

<p>HEADS UP COMMON SIZES</p>	 <p>Large HU-L 5.8" Neck Width 9" Long Arms Standard Foam</p>	 <p>Medium HU-M 4.6" Neck Width 9" Long Arms Standard Foam</p>	 <p>Small HU-S 4" Neck Width 5.6" Short Arms Standard Foam</p>	 <p>Early Intervention HU-I 3.3" Neck Width 5.6" Short Arms Standard Foam</p>
-------------------------------------	---	--	--	---



Sunrise Medical (US) LLC
12002 Volunteer Blvd. · Mount Juliet, TN 37122 · USA