

SERIAL NO: _____

AI
ALUMINIUM 7020



CE

Customer Contact Details

Customer Name: _____

Advisor: _____

Address: _____

Phone: _____

Email: _____

Ship to Customer Address:

Shipping Name: _____

Shipping Address: _____

Phone: _____

Email: _____

Additional Information

Notes: _____

Current Wheelchair: _____

Customer Weight: _____

Customer Height: _____

Customer Disability: _____

Other

VAT Exemption Declaration (UK Only):
 I declare that I am chronically sick or disabled by reason of:

 and that I am receiving from RGK Wheelchairs Ltd, the wheelchair specified herein and I claim relief from Value Added Tax under group 12 of schedule 8 to Value Added Tax Act 1994.
 Signature: _____ Date: _____

RGK Contact Authorisation:
 From time to time, RGK would like to send you exclusive information, news and offers on everything RGK, by email or post. We will not pass any of your details to any third party.
 I would like to be contacted by RGK:
 Signature: _____ Date: _____

SERIAL NO: _____

Guide: Base product Required option Optional Extra Critical Information Information Needed

PRODUCT STYLE

GCAXZ010 GRANDSLAM CX
\$7,212.00

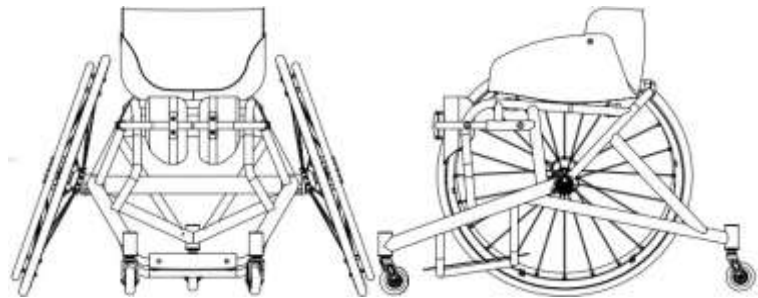

Max User Weight 125kg (275lbs)

PLEASE NOTE: ALL RGK CHAIRS ARE HAND BUILT AND HAVE A MANUFACTURING MEASUREMENT TOLERANCE OF +/- 5MM

CAD APPROVAL

XW009 QUOTE ONLY (NO CAD FOR APPROVAL)
\$0.00

XW011 ORDER (NO CAD FOR APPROVAL)
\$0.00

XW012 QUOTE CAD drawing for approval
\$421.00 (2 customer amendments ONLY)

XW010 ORDER CAD drawing for approval
\$260.00 (2 customer amendments ONLY)

KEY FRAME MEASUREMENTS

XY010 Seat width (Inside to inside of sideguards)



(Max - 390mm)
(Min=270mm)

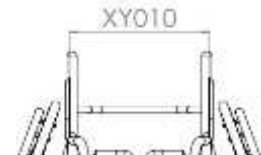

Select CX shell width (optional)

A-330mm XY010 = 270-315

C-380mm XY010 = 320-365

B-355mm XY010 = 295-340

D-405mm XY010 = 345-390

Hard foam will be used to get Seat width

Note: CX Shell Seat Taper

Seat Taper	Seat length (mm)				
	250	300	350	400	
330	305	280	255	230	
355	330	305	280	255	
380	355	330	305	280	
405	380	355	330	305	

XY020 Seat length



(Max - 500mm)

XY030 Extra seat length (not required with Knee support)



GCAXY050 Front seat height (Floor to middle of seat without cushion)



(Max - 630mm)
(Min - 360mm)

GCAXY060 Rear seat height (Floor to middle of seat without cushion)



(Max - 630mm)
(Min - 360mm)

XY070 Frame length



(Min = XY020 + XY030 + 140mm)

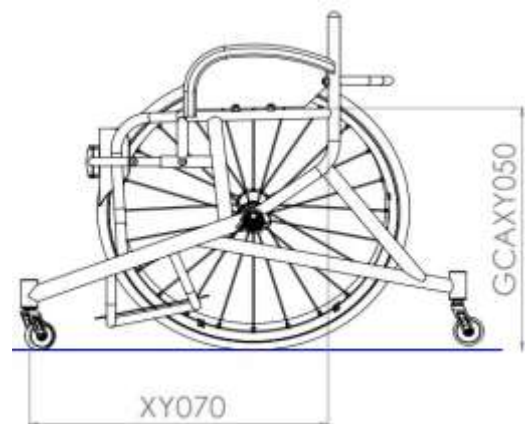
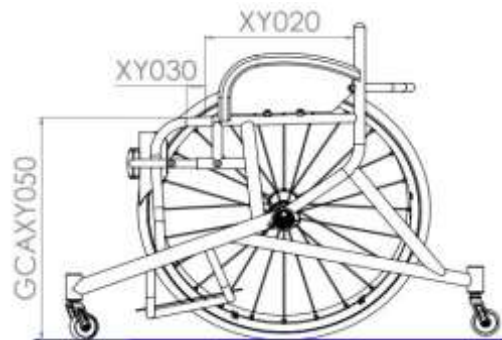

FRONT FRAME

XY080 Seat taper design

i Specify taper width
 mm



Knee support options

XA200 Knee support ratchet system
 (Tubes on the **outside** as std)

i Specify length
 mm

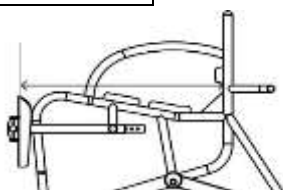

XA203 Carbon fibre shin pads
\$341.00 (Includes 7mm hard padding)

XA204 Extra padding for shin pads
\$83.00

i Specify padding thickness
 mm

Specify padding density

Medium Hard

FOOTREST

Footrest Type

GCAXB080 Fixed position footrest

Footrest Measurements

Front footrest height
 mm (min = 35mm)

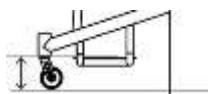

Footrest width
 mm (Std= 200mm)

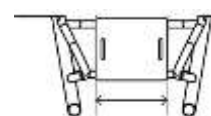

Rear footrest height
 mm (min = 35mm)

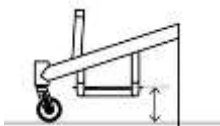

Footrest length
 mm (Std = 250mm)

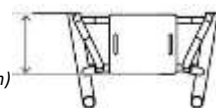

Footrest position
 (front of footplate to castor pot)
 mm

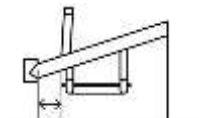

Footrest Plate

XB190 Carbon fibre footplate
\$219.00

XB100 ABS moulded foot tray
\$129.00

GCAXB140 Spacer kit
\$19.00 (Allows for 25mm increase in height)

i Specify length
 mm (Max = 380mm (Full) Std = 330mm)

Footrest Plate Options

XB240 Aluminium raised edges
\$75.00 (Cost per Edge)

Front Back Left Right

Specify height
 (Max = 60mm)

XB250 Carbon Fibre raised edge
\$290.00 (1 side only)

Front Back

Specify height
 (Max = 45mm)

Castor Pin Width

XY330 Castor pin width

w mm Optimise measurements

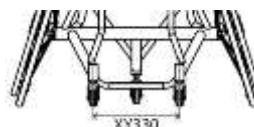

CAMBER BAR AND ANTI-TIP

Centre of Gravity and Camber Angle

GCAXY510 Fixed centre of gravity

Specify measurement mm



XY390 Camber angle

Specify measurement 18 20 22

Anti-tip options (Choose one)

GCAXJ040 Single fixed anti tip

Specify distance behind rear wheel mm (Std = 100mm)



CX SIDES

Side Measurements

Sideguard height (std = 150mm)(follow tyre)(Max = 180)

Specify measurement mm

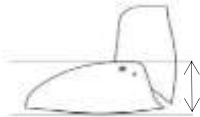

Backrest depth (std = 150mm)(Max =)

Specify measurement mm

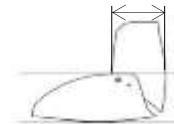

Individual Shape

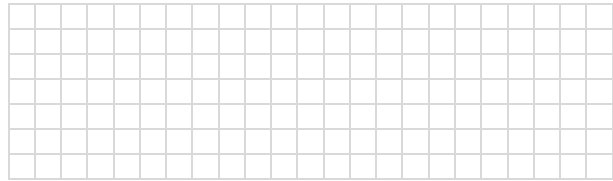
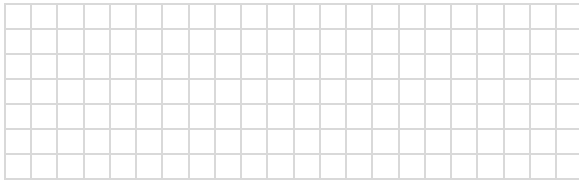

BACKREST

Backrest Height (Choose One)

XY230 Fixed backrest height

Specify height mm

Backrest depth **top** (distance from front of back post to middle of upholstery)

mm

Backrest depth **bottom** (distance from front of back post to middle of upholstery)

mm

Note: Take measurement from existing chair

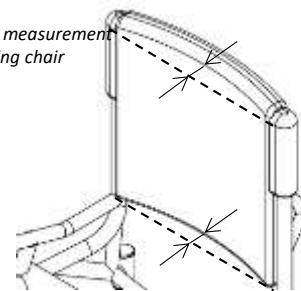

CASTOR AND REAR WHEELS			
Castor Options			
<input type="checkbox"/> XC160	Sport 61mm castor <i>(Std, Black)</i>	<input type="checkbox"/> XC181	Bones Reds bearings <i>(All castor bearings)</i>
<input type="checkbox"/> XC170	Sport 72mm castor <i>(Black)</i>	<input type="checkbox"/> XC182 \$278.00	Bones Swiss Ceramic bearings <i>(All castor bearings)</i>
Rear Wheel Size			
<input type="checkbox"/> XY420	24" Wheels	<input type="checkbox"/> XY430	25" Wheels
<input type="checkbox"/> XY440	26" Wheels	<input type="checkbox"/> XY450	700C Wheels
Rear Wheel Gap			
<input type="checkbox"/> XY460	Rear wheel gap	<input type="checkbox"/> XY470	Inside to inside of wheel
<input type="checkbox"/> 15 <input type="checkbox"/> 20 <input type="checkbox"/> 25 <input type="checkbox"/> 30 Individual <input style="width: 100px;" type="text"/> mm		OR	<input style="width: 100px;" type="text"/> mm
Rear Wheel Options			
<input type="checkbox"/> XK080	Spinergy SLX 24 spoke \$750.00	<input type="checkbox"/> XK521	Spinergy Ceramic bearing upgrade \$252.00
<input type="checkbox"/> XK100	Spinergy XSLX 24 spoke \$789.00		
Spinergy Colour Options:			
<input type="checkbox"/> Black spokes	<input type="checkbox"/> White spokes	<input type="checkbox"/> Yellow spokes	<input type="checkbox"/> XK180
<input type="checkbox"/> Red spokes	<input type="checkbox"/> Blue spokes	<input type="checkbox"/> Pink spokes	Individual spoke design \$175.00 <i>(Specify colour)</i>
<input type="checkbox"/> Purple spokes	<input type="checkbox"/> Orange spokes	<input type="checkbox"/> Green spokes	Inside: _____ Outside: _____
Spinergy Anodise Options			
<input type="checkbox"/> XK190	Black hub <i>(std option)</i>	<input type="checkbox"/> XK200	Silver hub \$92.00
<input type="checkbox"/> XK201	Red hub/rims \$274.00	<input type="checkbox"/> XK205	Individual hub/rims \$316.00 Select colour: _____
<input type="checkbox"/> XK202	Purple hub/rims \$274.00	<input type="checkbox"/> XK203	Blue hub/rims \$274.00
<input type="checkbox"/> XK204	Gold hub/rims \$274.00		
Supply Without Wheels			
<input type="checkbox"/> XK040	Supply without Wheels -\$184.00	<input style="width: 150px;" type="text"/> Wheel Type:	<input style="width: 150px;" type="text"/> Tyre Type:
Handrim Position / Options			
<input type="checkbox"/> XY480	Narrow set handrim	<input type="checkbox"/> XY485	Wide set handrim
<input type="checkbox"/> XL090	Remove excess mounting tabs <i>(recommended for small wheel gaps)</i> \$101.00		
Handrim Style			
<input type="checkbox"/> XL010	Aluminium hard anodised 6 tab	<input type="checkbox"/> XL040	Titanium 6 tab \$240.00 (Not with 700C)
<input type="checkbox"/> XL130	Aluminium hard anodised 6 tab Painted <i>(Select Colour)</i> \$67.00	<input type="checkbox"/> XL100	Para grip 6 tab \$283.00 (Not with 700C)
<input type="checkbox"/> XL070	Aluminium hard anodised 12 tab (24" not available) \$101.00	<input type="checkbox"/> XL020	Tetra Grip 6 tab \$283.00
Tyre Options			
<input type="checkbox"/> XM070	Kenda Kaliente	<input type="checkbox"/> Red <input type="checkbox"/> Blue	<input type="checkbox"/> XM080
<input type="checkbox"/> XM150	IRC Exeracer Pro <i>(Red Only)</i> \$83.00		Tufo MS3 tubeless \$83.00 <i>(Blue only)</i>
			<input type="checkbox"/> XM095
			Kenda Wide \$35.00 <i>(Grey Only)</i>
Spare Wheel			
<input type="checkbox"/> GCAXK500	Spare wheel Spinergy <i>(Built up + axle pin)</i> \$845.00	<input type="checkbox"/> XK523	Spare wheel upcharge - Individual Hubs/Rims \$122.00
<input type="checkbox"/> XK520	Spare wheel upcharge - Titanium Rims \$196.00	<input type="checkbox"/> XK524	Spare wheel upcharge - Individual Spoke Colour \$88.00
<input type="checkbox"/> XK522	Spare wheel upcharge - Remove Excess Tabs \$51.00		
Inner Tube Valve Options			
<input type="checkbox"/> XY500	Schraeder inner tube valve 	<input type="checkbox"/> XY490	Presta inner tube valve <i>(Standard if no option selected)</i>

FINISH OPTIONS

Frame finish

XN010 Powder coated frame

Frame **Gloss**

- Black gloss 103
- White gloss 100
- Grey gloss 132
- Cream gloss 135
- Red gloss 108
- Yellow gloss 120
- Forest green gloss 143
- Green gloss 107
- Dark blue gloss 151
- Royal blue gloss 154
- Blue gloss 174
- Duckegg blue gloss 141
- Pink gloss 188
- Orange gloss 180
- Purple gloss 157

Frame **Matt**

- Black matt 105
- White matt 101
- Grey matt 131
- Light grey matt 133
- Navy blue matt 152

Frame **Special**

- Chrome Mirror 300
- Sparkle silver 170
- Metallic black matt 104
- Metallic grey matt 130
- Black sandpaper 201
- Grey sandpaper 202
- White sandpaper 200

XN200 Individual paint colour (State Colour/RAL code)
\$172.00

GCAXN030 Brushed frame
\$347.00

GCAXN050 Polished frame
\$919.00

Accent Colour

Note: Accent colour includes, forks, castor caps, and logo decals.

- Black accent
- Red accent
- Purple accent

- Silver accent
- Blue accent
- Carbon accent

(caps only, otherwise black)

XN250 Individual accent
\$172.00

Select Colour:

UPHOLSTERY AND CUSHION

CX Options



XP200

CX seat and backrest upholstery

Seat cushion foam thickness

7mm 10mm 25mm 50mm Custom thickness

Backrest foam thickness

7mm 10mm 25mm 50mm Custom thickness

Indicate Max Height:

580mm 630mm

Seat cushion foam type

Soft Med Plastazote (Hard)

Backrest foam type

Soft Med Plastazote (Hard)

STRAPPING

Velcro straps

 XS050
\$119.00

100mm Pro adjustable velcro strap

 XS055
\$119.00

50mm Pro adjustable velcro strap

 XS057
\$119.00

50mm Pro adjustable velcro **Knee** strap
(measurement from tube to tube over knees)

Velcro strap position

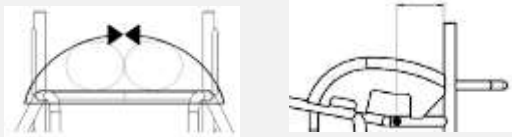
 Strap 1 Type

Specify strap length

 mm

Specify distance from back post

 mm

 Strap 2 Type

Specify strap length

 mm

Specify distance from back post

 mm

Ratchet Straps

 XS020
\$81.00

Sport ratchet strap (Click strap)
(11" x 2" pad)

 XS021
\$81.00

Sport ratchet strap (Single)

 XS025
\$212.00

Pelvi Loc 2DA ratchet strap
(For thighs and knees)

i Select size:

Medium (12") Large (14")

 XS030
\$227.00

Pelvi Loc 3DA ratchet strap
(For hips)

i Select size:

S (8") M (12") L (14") XL (17")

 XS035
\$135.00

M2 ratchet strap
(For thighs and knees)

i Select size:

8" 10" 12"

 XS036
\$135.00

M2 ratchet strap (Single)
(For Feet)

i Select size:

8" 10" 12"

Ratchet strap position

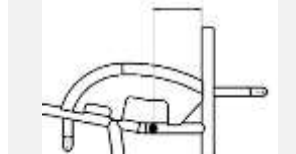
 Strap 1 Type

Specify distance from back post

 mm

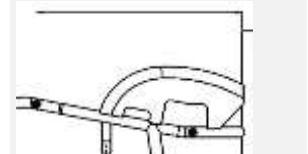
 Strap 2 Type

Specify distance from back post

 mm

 XS040
\$85.00

Fixed mounting points
(one set per click strap)

x1 x2 x3

FRAME OPTIONS

 XR060
\$101.00

Calf strap mounting loops

 XR065
\$101.00

Strap location loops



ACCESSORIES

 XR030
\$99.00

Triple wheel bag
(Black)

 XP130
\$90.00

Frame protectors full length

 XS100
\$90.00

Bodypoint waist strap

Small Large

 XS070

Foot strap (select if required)

 XS060

Calf strap (select if required)

 XP400

Back bar protector

 XR090

Tool kit

ADDITIONAL NOTES

OFF SPEC REQUEST*

(please specify below the page number(s) and details to which the off spec request applies.

**OFF SPEC REQUEST
APPROVED** *(for internal
RGK office only)*

X

RGK Internal Sign-off

Off spec requests require a feasibility study which may increase order price and lead time. Any dimension/ option/ frame request not listed on the order form will be treated as an off spec request.*