

SERIAL NO: \_\_\_\_\_

**AI**  
ALUMINIUM 7020



CE

**Customer Contact Details**

Customer Name: \_\_\_\_\_

RGK Genius: \_\_\_\_\_

Address: \_\_\_\_\_  
 \_\_\_\_\_  
 \_\_\_\_\_

Phone: \_\_\_\_\_

Email: \_\_\_\_\_

Ship to Customer Address:

Shipping Name: \_\_\_\_\_

Shipping Address: \_\_\_\_\_  
 \_\_\_\_\_  
 \_\_\_\_\_

Phone: \_\_\_\_\_

Email: \_\_\_\_\_

**Additional Information**

Notes: \_\_\_\_\_  
 \_\_\_\_\_  
 \_\_\_\_\_  
 \_\_\_\_\_

Current Wheelchair: \_\_\_\_\_

Customer Weight: \_\_\_\_\_

Customer Height: \_\_\_\_\_

Customer Disability: \_\_\_\_\_

**Other**

VAT Exemption Declaration (UK Only):  
 I declare that I am chronically sick or disabled by reason of:  
 \_\_\_\_\_  
 and that I am receiving from RGK Wheelchairs Ltd, the wheelchair specified herein and I claim relief from Value Added Tax under group 12 of schedule 8 to Value Added Tax Act 1994.  
 Signature: \_\_\_\_\_ Date: \_\_\_\_\_

RGK Contact Authorisation:  
 From time to time, RGK would like to send you exclusive information, news and offers on everything RGK, by email or post. We will not pass any of your details to any third party.  
 I would like to be contacted by RGK:  
 Signature: \_\_\_\_\_ Date: \_\_\_\_\_

SERIAL NO: \_\_\_\_\_

Guide:  Base product  Required option  Optional Extra Critical Information Information Needed

**PRODUCT STYLE**

**GCAXZ010 GRANDSLAM CX**  
\$7,500.00

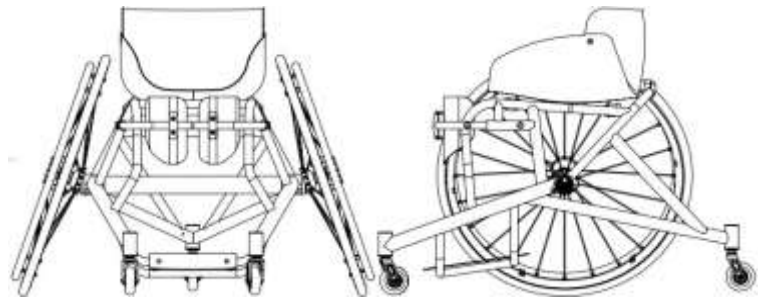

Max User Weight 125kg (275lbs)

PLEASE NOTE: ALL RGK CHAIRS ARE HAND BUILT AND HAVE A MANUFACTURING MEASUREMENT TOLERANCE OF +/- 5MM

**CAD APPROVAL**

|          |                                  |          |                                |
|----------|----------------------------------|----------|--------------------------------|
| XW009    | QUOTE ONLY (NO CAD FOR APPROVAL) | XW011    | ORDER (NO CAD FOR APPROVAL)    |
| \$0.00   |                                  | \$0.00   |                                |
| XW012    | QUOTE CAD drawing for approval   | XW010    | ORDER CAD drawing for approval |
| \$421.00 | (2 customer amendments ONLY)     | \$260.00 | (2 customer amendments ONLY)   |

**KEY FRAME MEASUREMENTS**

XY010 Seat width (Inside to inside of sideguards)  
 mm in (Max - 390mm)  
 (Min=270mm)

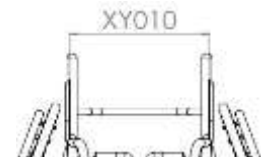

Select CX shell width (optional)

|         |                 |         |                 |
|---------|-----------------|---------|-----------------|
| A-330mm | XY010 = 270-315 | C-380mm | XY010 = 320-365 |
| B-355mm | XY010 = 295-340 | D-405mm | XY010 = 345-390 |

Note: CX Shell Seat Taper

| Seat Taper | Seat length (mm) |     |     |     |  |
|------------|------------------|-----|-----|-----|--|
|            | 250              | 300 | 350 | 400 |  |
| 330        | 305              | 280 | 255 | 230 |  |
| 355        | 330              | 305 | 280 | 255 |  |
| 380        | 355              | 330 | 305 | 280 |  |
| 405        | 380              | 355 | 330 | 305 |  |

Hard foam will be used to get Seat width

XY020 Seat length  
 mm in (Max - 500mm)

XY030 Extra seat length  
 (not required with Knee support)

mm in

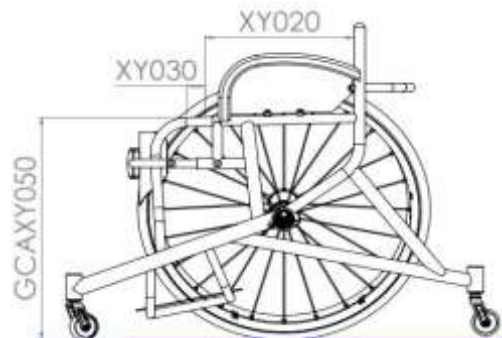

GCAXY050 Front seat height (Floor to middle of seat without cushion)  
 mm in (Max - 630mm)  
 (Min - 360mm)

GCAXY060 Rear seat height (Floor to middle of seat without cushion)  
 mm in (Max - 630mm)  
 (Min - 360mm)

XY070 Frame length  
 mm in (Min = XY020 + XY030 + 140mm)

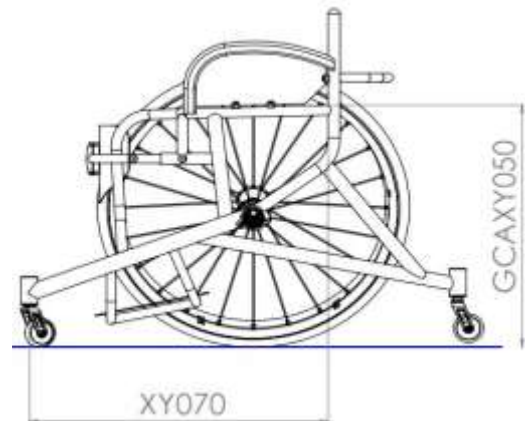

**FRONT FRAME**

XY080 Seat taper design



Specify taper width

mm in



**Knee support options**

XA200 Knee support ratchet system  
(Tubes on the **outside** as std)



Specify length

mm in

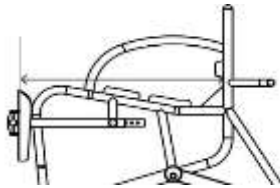

XA203 Carbon fibre shin pads  
\$358.00 (Includes 7mm hard padding)

XA204 Extra padding for shin pads  
\$88.00



Specify padding thickness

mm in

Specify padding density

Medium Hard

**FOOTREST**

**Footrest Type**

GCAXB080 Fixed position footrest

**Footrest Measurements**

Front footrest height

mm in

(min = 35mm)



Footrest width

mm in

(Std= 200mm)

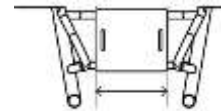

Rear footrest height

mm in

(min = 35mm)

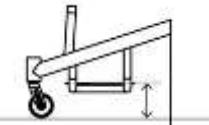

Footrest length

mm in

(Std = 250mm)

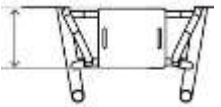

Footrest position

(front of footplate to castor pot)

mm in

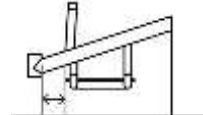

**Footrest Plate**

XB190 Carbon fibre footplate  
\$230.00

XB100 ABS moulded foot tray  
\$135.00

GCAXB140 Spacer kit  
\$19.00 (Allows for 25mm increase in height)



Specify length

mm in Max = 380mm (Full)  
Std = 330mm

**Footrest Plate Options**

XB240 Aluminium raised edges  
\$79.00 (Cost per Edge)

XB250 Carbon Fibre raised edge  
\$305.00 (1 side only)

Front Back Left Right

Front Back

Specify height

mm in

(Max = 60mm)

Specify height

mm in

(Max = 45mm)

**Castor Pin Width**

XY330 Castor pin width



mm in

Optimise measurements

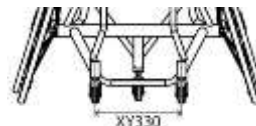

**CAMBER BAR AND ANTI-TIP**

Centre of Gravity and Camber Angle

GCAXY510 Fixed centre of gravity



Specify measurement  
mm in



XY390 Camber angle



18 20 22

Anti-tip options (Choose one)

GCAXJ040 Single fixed anti tip

Specify distance behind rear wheel

mm in (Std = 100mm)

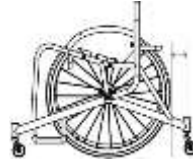

**CX SIDES**

Side Measurements

Sideguard height  
(std = 150mm)(follow tyre)(Max = 180)



mm in

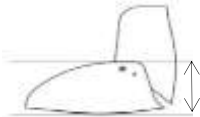

Backrest depth  
(std = 150mm)(Max = )



mm in

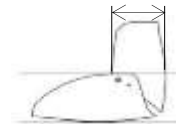

Individual Shape

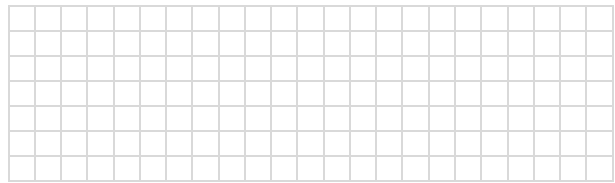
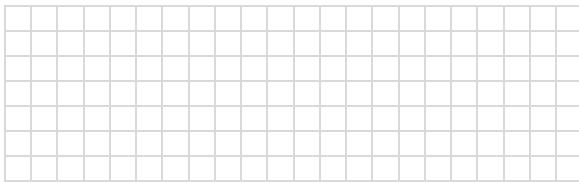

**BACKREST**

Backrest Height (Choose One)

XY230 Fixed backrest height



Specify height

mm in

Backrest depth **top**  
(distance from front of back post to middle of upholstery)

mm in

Backrest depth **bottom**  
(distance from front of back post to middle of upholstery)

mm in

Note: Take measurement from existing chair

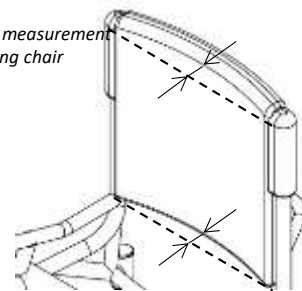

| CASTOR AND REAR WHEELS     |                                 |  |                  |               |                           |  |                                    |                                       |
|----------------------------|---------------------------------|--|------------------|---------------|---------------------------|--|------------------------------------|---------------------------------------|
| Castor Options             |                                 |  |                  |               |                           |  |                                    |                                       |
|                            | XC160                           | Sport 61mm castor<br><i>(Std, Black)</i>                                 |                  |               | XC181                     | Bones Reds bearings<br><i>(All castor bearings)</i>                |                                    |                                       |
|                            | XC170                           | Sport 72mm castor<br><i>(Black)</i>                                      |                  |               | XC182                     | Bones Swiss Ceramic bearings<br><i>(All castor bearings)</i>       |                                    |                                       |
|                            |                                 |  |                  |               | <b>\$292.00</b>           |  |                                    |                                       |
| Rear Wheel Size            |                                 |  |                  |               |                           |  |                                    |                                       |
|                            | XY420                           | 24" Wheels   |                  | XY430         | 25" Wheels                |  | XY440 26" Wheels XY450 700C Wheels |                                       |
| Rear Wheel Gap             |                                 |  |                  |               |                           |  |                                    |                                       |
|                            | XY460                           | Rear wheel gap   |                  | XY470         | Inside to inside of wheel |  |                                    |                                       |
|                            | 15                              | 20   | 25               | 30            |                           | mm   | in                                 |                                       |
| <i>Individual</i>          |                                 | mm   |                  | in            |                           |  |                                    |                                       |
|                            |                                 |  |                  | OR            |                           |  |                                    |                                       |
| Rear Wheel Options         |                                 |  |                  |               |                           |  |                                    |                                       |
|                            | XK080                           | Spinergy SLX 24 spoke  |                  |               | XK521                     | Spinergy Ceramic bearing upgrade                                   |                                    |                                       |
|                            | <b>\$787.00</b>                 |  |                  |               | <b>\$264.00</b>           |  |                                    |                                       |
|                            | XK100                           | Spinergy XSLX 24 spoke   |                  |               |                           |  |                                    |                                       |
|                            | <b>\$829.00</b>                 |  |                  |               |                           |  |                                    |                                       |
|                            | <b>Spinergy Colour Options:</b> |  |                  |               |                           |  |                                    |                                       |
|                            | Black spokes                    | White spokes   | Yellow spokes    |               | XK180                     | Individual spoke design<br><i>(Specify colour)</i>                 |                                    |                                       |
|                            | Red spokes                      | Blue spokes  | Pink spokes      |               | <b>\$184.00</b>           |  |                                    |                                       |
|                            | Purple spokes                   | Orange spokes  | Green spokes     |               |                           | <i>Inside:</i>   |                                    |                                       |
|                            |                                 |  |                  |               |                           | <i>Outside:</i>  |                                    |                                       |
|                            | <b>Spinergy Anodise Options</b> |  |                  |               |                           |  |                                    |                                       |
|                            | XK190                           | Black hub<br><i>(std option)</i>   | XK200            | Silver hub    | XK201                     | Red hub/rims   | XK205                              | Individual hub/rims<br>Select colour: |
|                            |                                 |  | <b>\$96.00</b>   |               | <b>\$287.00</b>           |  | <b>\$332.00</b>                    |                                       |
|                            | XK202                           | Purple hub/rims  | XK203            | Blue hub/rims | XK204                     | Gold hub/rims  |                                    |                                       |
|                            | <b>\$287.00</b>                 |  | <b>\$287.00</b>  |               | <b>\$287.00</b>           |  |                                    |                                       |
| Supply Without Wheels      |                                 |  |                  |               |                           |  |                                    |                                       |
|                            | XK040                           | Supply without Wheels  |                  |               |                           |  |                                    |                                       |
|                            |                                 |  | <b>-\$193.00</b> |               |                           |  |                                    |                                       |
| Handrim Position / Options |                                 |  |                  |               |                           |  |                                    |                                       |
|                            | XY480                           | Narrow set handrim   |                  |               | XY485                     | Wide set handrim   |                                    |                                       |
|                            | XL090                           | Remove excess mounting tabs<br><i>(recommended for small wheel gaps)</i> |                  |               |                           |  |                                    |                                       |
|                            | <b>\$106.00</b>                 |  |                  |               |                           |  |                                    |                                       |
| Handrim Style              |                                 |  |                  |               |                           |  |                                    |                                       |
|                            | XL010                           | Aluminium hard anodised <b>6 tab</b>                                     |                  |               | XL040                     | Titanium 6 tab<br><b>(Not with 700C)</b>                           |                                    |                                       |
|                            |                                 |  |                  |               | <b>\$252.00</b>           |  |                                    |                                       |
|                            | XL130                           | Aluminium hard anodised <b>6 tab Painted</b><br><i>(Select Colour)</i>   |                  |               | XL100                     | Para grip 6 tab<br><b>(Not with 700C)</b>                          |                                    |                                       |
|                            | <b>\$70.00</b>                  |  |                  |               | <b>\$297.00</b>           |  |                                    |                                       |
|                            | XL070                           | Aluminium hard anodised <b>12 tab</b><br><b>(24" not available)</b>      |                  |               | XL020                     | Tetra Grip 6 tab   |                                    |                                       |
|                            | <b>\$106.00</b>                 |  |                  |               | <b>\$297.00</b>           |  |                                    |                                       |
| Tyre Options               |                                 |  |                  |               |                           |  |                                    |                                       |
|                            | XM070                           | Kenda Kaliente   | Red              | Blue          | XM080                     | Tufo MS3 tubeless<br><i>(Blue only)</i>                            |                                    |                                       |
|                            |                                 |  |                  |               | <b>\$87.00</b>            |  |                                    |                                       |
|                            | XM150                           | IRC Exeracer Pro<br><i>(Red Only)</i>                                    |                  |               | XM095                     | Kenda Wide<br><b>(Grey Only)</b>                                   |                                    |                                       |
|                            | <b>\$87.00</b>                  |  |                  |               | <b>\$37.00</b>            |  |                                    |                                       |
| Spare Wheel                |                                 |  |                  |               |                           |  |                                    |                                       |
|                            | GCAXK500                        | Spare wheel Spinergy<br><i>(Built up + axle pin)</i>                     |                  |               | XK523                     | Spare wheel upcharge - Individual Hubs/Rims                        |                                    |                                       |
|                            | <b>\$887.00</b>                 |  |                  |               | <b>\$128.00</b>           |  |                                    |                                       |
|                            | XK520                           | Spare wheel upcharge - Titanium Rims                                     |                  |               | XK524                     | Spare wheel upcharge - Individual Spoke Colour                     |                                    |                                       |
|                            | <b>\$206.00</b>                 |  |                  |               | <b>\$92.00</b>            |  |                                    |                                       |
|                            | XK522                           | Spare wheel upcharge - Remove Excess Tabs                                |                  |               |                           |  |                                    |                                       |
|                            | <b>\$54.00</b>                  |  |                  |               |                           |  |                                    |                                       |
| Inner Tube Valve Options   |                                 |  |                  |               |                           |  |                                    |                                       |
|                            | XY500                           | Schraeder inner tube valve   |                  |               | XY490                     | Presta inner tube valve<br><i>(Standard if no option selected)</i> |                                    |                                       |
|                            |                                 |  |                  |               |                           |  |                                    |                                       |

**FINISH OPTIONS**

Frame finish

XN010 Powder coated frame

Frame

**Gloss**

- Black gloss 103
- White gloss 100
- Grey gloss 132
- Cream gloss 135
- Red gloss 108
- Yellow gloss 120
- Forest green gloss 143
- Green gloss 107
- Dark blue gloss 151
- Royal blue gloss 154
- Blue gloss 174
- Duckegg blue gloss 141
- Pink gloss 188
- Orange gloss 180
- Purple gloss 157

Frame

**Matt**

- Black matt 105
- White matt 101
- Grey matt 131
- Light grey matt 133
- Navy blue matt 152

Frame

**Special**

- Chrome Mirror 300
- Sparkle silver 170
- Metallic black matt 104
- Metallic grey matt 130
- Black sandpaper 201
- Grey sandpaper 202
- White sandpaper 200

XN200 Individual paint colour (State Colour/RAL code)  
\$180.00

GCAAXN030 Brushed frame  
\$365.00

GCAAXN050 Polished frame  
\$965.00

Accent Colour

**Note:** Accent colour includes, forks, castor caps, and logo decals.



- Black accent
- Red accent
- Purple accent

- Silver accent
- Blue accent
- Carbon accent

XN250 Individual accent  
\$180.00

**(caps only, otherwise black)**

**UPHOLSTERY AND CUSHION**

CX Options

|                                     |       |                                 |       |       |                  |                        |     |                   |
|-------------------------------------|-------|---------------------------------|-------|-------|------------------|------------------------|-----|-------------------|
| <input checked="" type="checkbox"/> | XP200 | CX seat and backrest upholstery |       |       |                  | Seat cushion foam type |     |                   |
|                                     |       | Seat cushion foam thickness     |       |       |                  | Soft                   | Med | Plastazote (Hard) |
|                                     | 7mm   | 10mm                            | 25mm  | 50mm  | Custom thickness |                        |     |                   |
|                                     |       |                                 |       | mm    | in               |                        |     |                   |
|                                     |       | Backrest foam thickness         |       |       |                  | Backrest foam type     |     |                   |
|                                     | 7mm   | 10mm                            | 25mm  | 50mm  | Custom thickness | Soft                   | Med | Plastazote (Hard) |
|                                     |       |                                 |       | mm    | in               |                        |     |                   |
| <i>Indicate Max Height:</i>         |       |                                 |       |       |                  |                        |     |                   |
|                                     |       |                                 | 580mm | 630mm |                  |                        |     |                   |

**STRAPPING**

Velcro straps

|       |   |                 |
|-------|---|-----------------|
| XS050 | 100mm Pro adjustable velcro strap   | <b>\$125.00</b> |
| XS055 | 50mm Pro adjustable velcro strap  | <b>\$125.00</b> |
| XS057 | 50mm Pro adjustable velcro <b>Knee</b> strap<br><i>(measurement from tube to tube over knees)</i> | <b>\$125.00</b> |

Velcro strap position

Strap 1

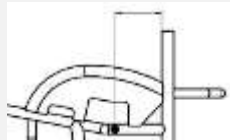
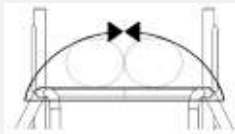

Specify strap length

mm in

Specify distance from back post

mm in

Strap 2

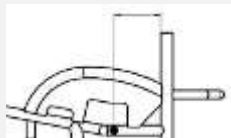
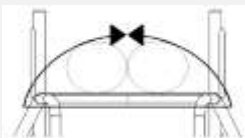

Specify strap length

mm in

Specify distance from back post

mm in

Ratchet Straps

|       |  |                 |
|-------|--|-----------------|
| XS020 | Sport ratchet strap (Click strap)<br><i>(11" x 2" pad)</i>   | <b>\$85.00</b>  |
| XS021 | Sport ratchet strap (Single)                                 | <b>\$86.00</b>  |
| XS025 | Pelvi Loc 2DA ratchet strap<br><i>(For thighs and knees)</i> | <b>\$222.00</b> |



Select size:

Medium (12") Large (14")

|       |  |                 |
|-------|--|-----------------|
| XS030 | Pelvi Loc 3DA ratchet strap<br><i>(For hips)</i> | <b>\$238.00</b> |
|-------|--|-----------------|



Select size:

S (8") M (12") L (14") XL (17")

|       |   |                 |
|-------|---|-----------------|
| XS035 | M2 ratchet strap<br><i>(For thighs and knees)</i> | <b>\$142.00</b> |
|-------|---|-----------------|



8" 10" 12"

|       |  |                 |
|-------|--|-----------------|
| XS036 | M2 ratchet strap (Single)<br><i>(For Feet)</i> | <b>\$142.00</b> |
|-------|--|-----------------|



8" 10" 12"

Ratchet strap position

Strap 1

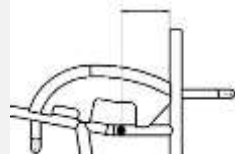

Specify distance from back post

mm in

Strap 2

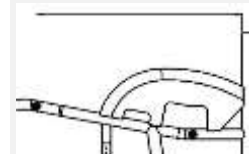

Specify distance from back post

mm in

|       |   |                |
|-------|---|----------------|
| XS040 | Fixed mounting points<br><i>(one set per click strap)</i> | <b>\$89.00</b> |
|-------|---|----------------|

x1 x2 x3

**FRAME OPTIONS**

|       |                           |                 |
|-------|---------------------------|-----------------|
| XR060 | Calf strap mounting loops | <b>\$106.00</b> |
|-------|---------------------------|-----------------|



|       |                      |                 |
|-------|----------------------|-----------------|
| XR065 | Strap location loops | <b>\$106.00</b> |
|-------|----------------------|-----------------|



**ACCESSORIES**

|       |                                    |                 |
|-------|------------------------------------|-----------------|
| XR030 | Triple wheel bag<br><i>(Black)</i> | <b>\$104.00</b> |
| XP130 | Frame protectors full length       | <b>\$95.00</b>  |
| XS100 | Bodypoint waist strap              | <b>\$95.00</b>  |
|       | Small Large                        |                 |

|   |  |
|---|--|
| XS070                                     | Foot strap <i>(select if required)</i> |
| XS060                                     | Calf strap <i>(select if required)</i> |
| <input checked="" type="checkbox"/> XP400 | Back bar protector                     |
| <input checked="" type="checkbox"/> XR090 | Tool kit                               |

ADDITIONAL NOTES

Grid area for additional notes.

**OFF SPEC REQUEST\*** *(please specify below the page number(s) and details to which the off spec request applies.*

**OFF SPEC REQUEST  
APPROVED** *(for internal  
RGK office only)*

X  
*RGK Internal Sign-off*

Off spec requests require a feasibility study which may increase order price and lead time. Any dimension/ option/ frame request not listed on the order form will be treated as an off spec request.\*

**Estimated MSRP\***