

AI
ALUMINIUM 7020



CE

Customer Contact Details

Customer Name: _____

RGK Genius: _____

Address: _____

Phone: _____

Email: _____

Ship to Customer Address:

Shipping Name: _____

Shipping Address: _____

Phone: _____

Email: _____

Additional Information

Notes: _____

Current Wheelchair: _____

Customer Weight: _____

Customer Height: _____

Customer Disability: _____

Other

VAT Exemption Declaration (UK Only):
 I declare that I am chronically sick or disabled by reason of:

 and that I am receiving from RGK Wheelchairs Ltd, the wheelchair specified herein and I claim relief from Value Added Tax under group 12 of schedule 8 to Value Added Tax Act 1994.
 Signature: _____ Date: _____

RGK Contact Authorisation:
 From time to time, RGK would like to send you exclusive information, news and offers on everything RGK, by email or post. We will not pass any of your details to any third party.
 I would like to be contacted by RGK:
 Signature: _____ Date: _____

SERIAL NO: _____

Guide: Base product Required option Optional Extra Critical Information Information Needed

PRODUCT STYLE

EXAXZ010 ELITE X
\$6,641.00

- XA600 Heat treated frame
- EXAXA062 Standard
- EXAXA063 Standard with 25mm seatrail
\$80.00



Max User Weight 125kg (275lbs)

PLEASE NOTE: ALL RGK CHAIRS ARE HAND BUILT AND HAVE A MANUFACTURING MEASUREMENT TOLERANCE OF +/- 5MM

CAD APPROVAL

CAD approved by: Customer RGK Genius

XW009 QUOTE ONLY (NO CAD FOR APPROVAL)
\$0.00

XW011 ORDER (NO CAD FOR APPROVAL)
\$0.00

XW012 QUOTE CAD drawing for approval
\$483.00 (2 customer amendments ONLY)

XW010 ORDER CAD drawing for approval
\$299.00 (2 customer amendments ONLY)

KEY MEASUREMENTS

XY010 Seat width (*Inside to inside of sideguards*)
 mm in (*Max - 500mm*)

XY020 Seat length
 mm in (*Max - 500mm*)

XY030 Extra seat length (*Provides additional leg support & hand grip*)
 mm in

XY050 Front frame height
 mm in (*Max - 630mm*
Min - 360mm)

XY060 Rear frame height
 mm in (*Max - 630mm*
Min - 360mm)

XY070 Frame length
 mm in (*Min = XY020 + XY030 + 140mm*)

XA020 Ergonomic seat
\$96.00
Specify length
 mm in (*Standard = 120mm*)

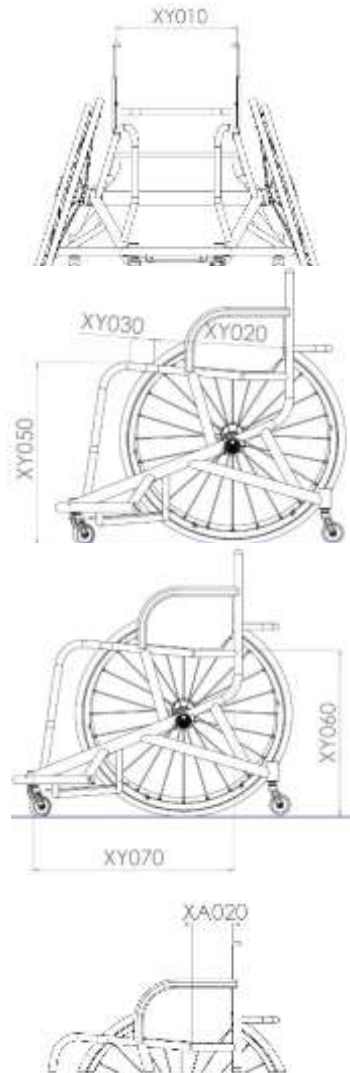

FRONT FRAME AND SEAT

Front Frame Options

XY080 Seat taper design

i Specify taper width
mm in



XA130 V-seat design
\$255.00

i Specify taper width
mm in

NOTE: INSIDE TO INSIDE WHEEL (XY470) REQUIRED



Advanced Front Frame Options

XY082 Seat taper position
\$95.00

i Specify measurement
mm in

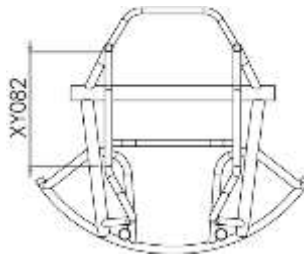

XA131 V-seat and taper design
\$345.00

i Specify inside width at front of sideguard (A)
mm in

i Specify taper width (B)
mm in

NOTE: INSIDE TO INSIDE WHEEL (XY470) REQUIRED

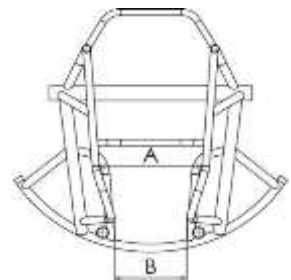

XA136 Parallel taper design
\$95.00 (Not with Seat Taper XY080)

i Specify taper width

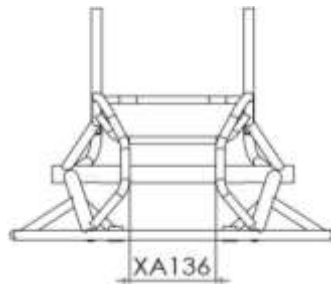

XA135 Asymmetrical taper design
\$403.00

i Specify taper width (A)
mm in

i Specify offset (B) (Inside of sideguard to inside of taper width)
mm in

i Specify offset taper side
Left Right

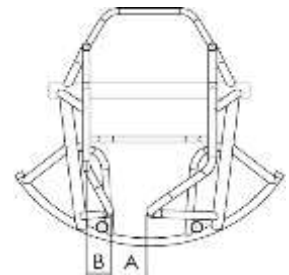

Seat Options

XR050 Carbon fibre seat plate
\$407.00 (riveted to frame)

i Specify length of plate
mm in (Std XY020 - 20mm)

XA260 Drop seat design
\$222.00 (only with either XR040 or 050)

i Specify drop
mm in (Std = 20mm)

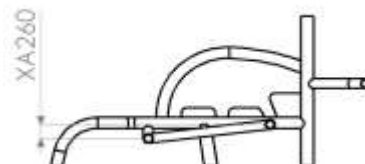

SIDEGUARDS

Sideguard Style

EXAXE230 Welded aluminium sport
\$430.00

XE310 High design upgrade
\$202.00



EXAXE250 Welded aluminium sport with Carbon Fibre
\$951.00

Sideguard Design (Choose One)

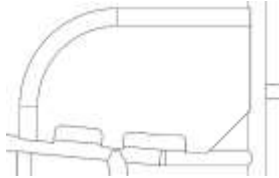

Straight design

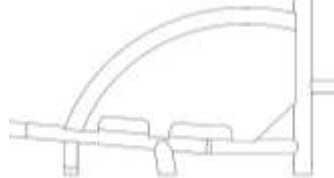

Round design



Follow tyre

Sideguard Measurements

Sideguard length

mm in



Sideguard height (back)

mm in

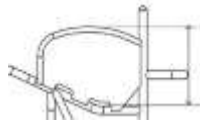

Sideguard height (front)
(optional)

mm in



Follow Tyre Design

25mm above tyre



Individual above tyre

mm in

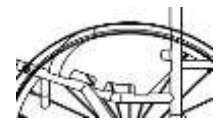

Level with tyre

BACKREST

Backrest Height

XY230 Fixed backrest height



Specify height

mm in



Ergonomic Options

XY360 Backrest angle

-5 -3 0 +3 +5

Individual
(Max -10/+10 Deg)

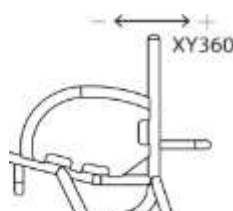

XG100 Ergonomic backrest
\$96.00

Vertical height



mm in

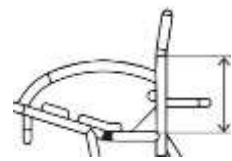

Rearward position



mm in



XG110 Inward taper
(inside of backrest posts)
\$96.00

Specify width / per side



mm in

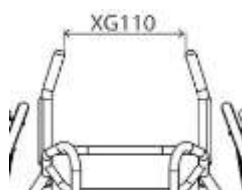

XG120 Outward flare
(inside of backrest posts)
\$96.00

Specify width / per side



mm in

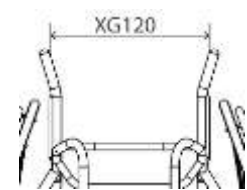

CASTOR AND REAR WHEELS

Castor Options

XC160 Sport 61mm castor (Black)	XC181 Bones Reds bearings (All castor bearings)
XC200 Sport micro fork	XC182 Bones Swiss Ceramic bearings (All castor bearings) \$335.00

Rear Wheel Size

XY420 24" Wheels	XY430 25" Wheels	XY440 26" Wheels	XY450 700C Wheels
------------------	------------------	------------------	-------------------

Rear Wheel Gap

XY460 Rear wheel gap 15 20 25 30 Individual mm in 	OR	XY470 Inside to inside of wheel mm in NOTE: REQUIRED FOR V SEAT AND TAPER
---	----	---

Rear Wheel Options

XK080 Spinerger SLX 24 spoke \$902.00	XK330 Spinerger SLX R10 heavy duty 24 spoke (18 deg camber angle only) \$1,589.00
XK101 Spinerger XSLX 24 spoke + Caps \$951.00	XK521 Spinerger Ceramic bearing upgrade \$289.00

Spinerger Colour Options:

Black spokes	White spokes	Yellow spokes	XK180 Individual spoke design \$212.00 (Specify colour)
Red spokes	Blue spokes	Pink spokes	
Purple spokes	Orange spokes	Green spokes	Inside: Outside:

Spinerger Anodise Options

XK190 Black hub (std option)	XK200 Silver hub \$111.00	XK201 Red hub/rims \$329.00	XK205 Individual hub/rims Select colour: \$381.00
XK202 Purple hub/rims \$329.00	XK203 Blue hub/rims \$329.00	XK204 Gold hub/rims \$329.00	

Supply Without Wheels

XK040 Supply without Wheels -\$222.00	
---	--

Handrim Position / Options

XY480 Narrow set handrim	XY485 Wide set handrim
XL090 Remove excess mounting tabs (recommended for small wheel gaps) \$122.00	XL080 Super narrow set handrim (only with XL040 and includes XL090) \$233.00

Handrim Style

XL010 Aluminium hard anodised 6 tab	XL040 Titanium 6 tab \$290.00 (Not with 700C)
XL070 Aluminium hard anodised 12 tab (24" not available) \$122.00	XL050 Stainless steel 6 tab \$152.00

Tyre Options

XM070 Kenda Kaliente \$100.00	Red Blue	XM095 Kenda Wide (Grey Only) \$43.00
XM150 IRC Exeracer Pro (Red Only) \$100.00		
XM080 Tufo MS3 tubeless (Blue only) \$100.00		

Spare Wheel

EXAXK500 Spare wheel Spinerger (Built up + axle pin) \$1,018.00	XK523 Spare wheel upcharge - Individual Hubs/Rims \$147.00
XK520 Spare wheel upcharge - Titanium Rims \$237.00	XK524 Spare wheel upcharge - Individual Spoke Colour \$107.00
XK522 Spare wheel upcharge - Remove Excess Tabs \$63.00	

XY500 Schraeder inner tube valve 	XY490 Presta inner tube valve (Standard if no option selected)
--------------------------------------	---

CUSHION

Cushion foam options

XP080 \$96.00	Cushion foam <i>(select density and size below)</i>	Soft (CMS040)	Medium (CMS050)				
		50mm	75mm	100mm	Other	mm	in
XP340 \$90.00	Hard Plastazote cushion upgrade <i>(Indicate max height)</i>	580mm	630mm				

Cushion Cover Upgrades

XP085	Nylon cushion cover <i>(Black)</i>	XP090 \$74.00	Air Lite cushion cover <i>(Black)</i>	XP380 \$102.00	Neoprene cushion cover <i>(Black)</i>
-------	---------------------------------------	-------------------------	--	--------------------------	--

STRAPS

Velcro straps

XS050 \$137.00	100mm Pro adjustable velcro strap
XS055 \$137.00	50mm Pro adjustable velcro strap
XS057 \$137.00	50mm Pro adjustable velcro Knee strap <i>(measurement from tube to tube over knees)</i>

Velcro strap position

Strap 1

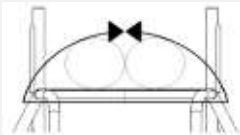

Specify strap length

mm in



Specify distance from back post

mm in

Strap 2

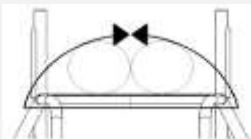

Specify strap length

mm in

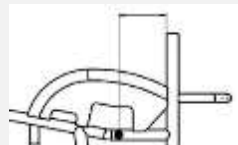

Specify distance from back post

mm in

Ratchet Straps

XS020 \$93.00	Sport ratchet strap (Click strap) <i>(11" x 2" pad)</i>
XS021 \$93.00	Sport ratchet strap (Single)
XS025 \$243.00	Pelvi Loc 2DA ratchet strap <i>(For thighs and knees)</i>

Select size:

i Medium (12") Large (14")

XS030 \$260.00	Pelvi Loc 3DA ratchet strap <i>(For hips)</i>
--------------------------	--

Select size:

i S (8") M (12") L (14") XL (17")

XS035 \$155.00	M2 ratchet strap <i>(For thighs and knees)</i>
--------------------------	---

i 8" 10" 12"

XS036 \$155.00	M2 ratchet strap (Single) <i>(For Feet)</i>
--------------------------	--

i 8" 10" 12"

Ratchet strap position

Strap 1

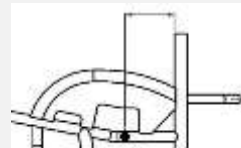

Specify distance from back post

mm in

Strap 2



Specify distance from back post

mm in

\$97.00	Fixed mounting points <i>(one set per click strap)</i>	x1	x2	x3
----------------	---	----	----	----

FRAME OPTIONS

XR060 \$116.00	Calf strap mounting loops
--------------------------	---------------------------



XR065 \$116.00	Strap location loops
--------------------------	----------------------

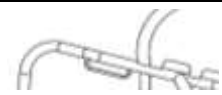

ACCESSORIES

XR030 \$114.00	Triple wheel bag <i>(Black)</i>	XS070	Foot strap <i>(select if required)</i>
XP130 \$104.00	Frame protectors full length	XS060	Calf strap <i>(select if required)</i>
XA150 \$74.00	Plastic tube fitted to offensive wing	XP400	Back bar protector
		XR090	Tool kit

ADDITIONAL NOTES

INDIVIDUAL BACKREST EMBROIDERY

PLEASE PROVIDE JPEG IMAGE AT TIME OF ORDER AND NOTE POSITION BELOW



BRACE BAR

SPEC NOTES:

OFF SPEC REQUEST* *(please specify below the page number(s) and details to which the off spec request applies.*

OFF SPEC REQUEST APPROVED *(for internal RGK office only)*

X
RGK Internal Sign-off

Off spec requests require a feasibility study which may increase order price and lead time. Any dimension/ option/ frame request not listed on the order form will be treated as an off spec request.*

Estimated MSRP*