

SERIAL NO: _____

AI
ALUMINIUM 7020



CE

Customer Contact Details

Customer Name: _____

RGK Genius: _____

Address: _____

Phone: _____

Email: _____

Ship to Customer Address:

Shipping Name: _____

Shipping Address: _____

Phone: _____

Email: _____

Additional Information

Notes: _____

Current Wheelchair: _____

Customer Weight: _____

Customer Height: _____

Customer Disability: _____

Other

VAT Exemption Declaration (UK Only):

I declare that I am chronically sick or disabled by reason of:

and that I am receiving from RGK Wheelchairs Ltd, the wheelchair specified herein and I claim relief from Value Added Tax under group 12 of schedule 8 to Value Added Tax Act 1994.

Signature: _____ Date: _____

RGK Contact Authorisation:

From time to time, RGK would like to send you exclusive information, news and offers on everything RGK, by email or post. We will not pass any of your details to any third party.

I would like to be contacted by RGK:

Signature: _____ Date: _____

Guide:



Base product



Required option



Optional Extra



Critical Information



Information Needed

PRODUCT STYLE

GXAXZ010 GRANDSLAM X
\$6,600.00

Max User Weight 125kg (275lbs)

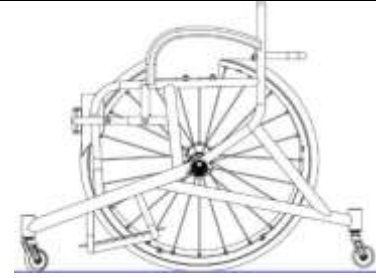

PLEASE NOTE: ALL RGK CHAIRS ARE HAND BUILT AND HAVE A MANUFACTURING MEASUREMENT TOLERANCE OF +/- 5MM

CAD APPROVAL

XW009 QUOTE ONLY (NO CAD FOR APPROVAL)
\$0.00

XW011 ORDER (NO CAD FOR APPROVAL)
\$0.00

CAD approved by: Customer RGK Genius

XW012 QUOTE CAD drawing for approval
\$483.00 (2 customer amendments ONLY)

XW010 ORDER CAD drawing for approval
\$298.00 (2 customer amendments ONLY)

KEY MEASUREMENTS

XY010 Seat width (*Inside to inside of sideguards*)
mm in (Max - 500mm)



XY020 Seat length
mm in (Max - 500mm)



XY030 Extra seat length (*not required with Knee support*)



XY050 Front frame height
mm in (Max - 630mm)
(Min - 360mm)



XY060 Rear frame height
mm in (Max - 630mm)
(Min - 360mm)



XY070 Frame length
mm in (Min XY020 + XY030 + 110mm)



XA020 Ergonomic seat
\$96.00
Specify length
mm in (Standard = 120mm)

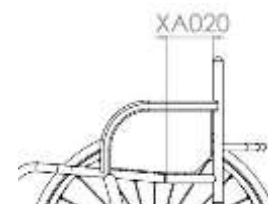
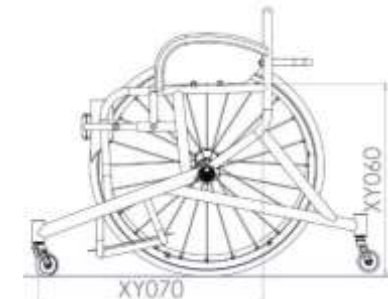
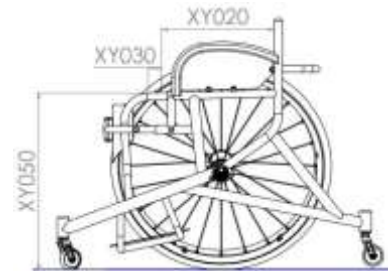
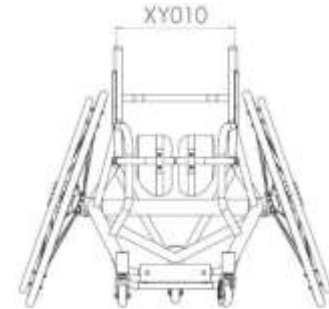

FRAME OPTIONS

Front Frame Options (Choose One)

XY080 Seat taper design



Specify taper width

mm in

(Optional, to provide additional leg support / positioning)



XA130 V-seat design

\$255.00



Specify taper width

mm in

NOTE: INSIDE TO INSIDE WHEEL (XY470) REQUIRED

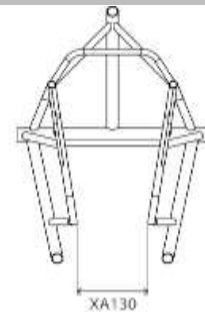

XA136 Frame front seat parallel design

\$100.00



Specify width

mm in

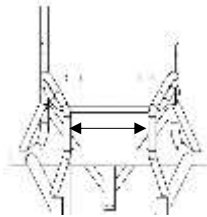

XA131 V-seat and Seat Taper Design

\$344.00

Specify inside width at front of sideguard (A)

mm in

Specify taper width (B)

mm in

NOTE: INSIDE TO INSIDE WHEEL (XY470) REQUIRED

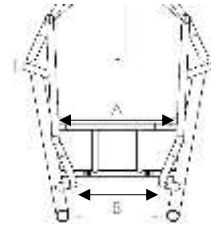

Knee Support Options

XA200 Knee support ratchet system
(Tubes on the **outside** as std)



Specify length

mm in

Optimise (Smallest)



XA202 Plastic shin pads
(Includes 5mm padding)

XA203 Carbon fibre shin pads
(Includes 7mm hard padding)

XA204 Extra padding for shin pads
\$101.00

mm in

Specify padding thickness



mm in

Specify padding density

Medium Hard

Seat Options

XR040 Aluminum seat plate
\$159.00 (riveted to frame)



Specify length of plate

mm in (Std XY020 - 20mm)

XR050 Carbon fibre seat plate
\$407.00 (riveted to frame)



Specify length of plate

mm in (Std XY020 - 20mm)

FOOTREST

Footrest Type

■ GXAXB080 Fixed position footrest

Footrest Measurements

Front footrest height

mm in

(min = 35mm)

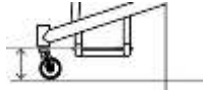

Footrest width

mm in

(Std= 200mm)

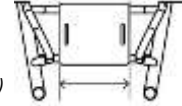

Rear footrest height

mm in

(min = 35mm)



Footrest length

mm in

(Std = 250mm)



Footrest position

(front of footplate to castor pot)

mm in

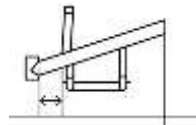

Footrest Plate

XB180 Aluminium footplate
(2.5mm)

GXAXB140 Spacer kit
\$22.00 (Allows for 25mm increase in height)

XB190 Carbon fibre footplate
\$264.00

XB100 ABS moulded foot tray
\$155.00

Specify length



mm in

Max = 380mm (Full)
Std = 330mm

Footrest Plate Options

XB240 Aluminium raised edges
\$90.00 (Cost per Edge)

XB250 Carbon Fibre raised edge
\$349.00 (1 side only)

Front Back Left Right

Front Back

Specify height

mm in

(Max = 60mm)

Specify height

mm in

(Max = 45mm)

Castor Pin Width

■ XY330 Castor pin width



mm in

Optimise measurements

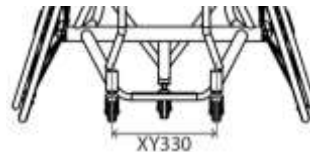

CAMBER BAR, WING AND ANTI-TIP

Centre of Gravity

GXAXY510 Fixed centre of gravity



Specify measurement

mm in

(Note: dimension is taken from front of backrest post to centre of

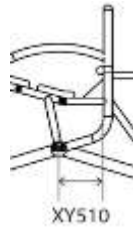

Camber Angle & Anti Tip

XY390 Camber angle



18 20 22

GXAXJ040 Single fixed anti tip



Specify distance behind rear wheel

mm in

(Std = 100mm)



SIDEGUARDS

Sideguard Style

GXAXE240 Welded aluminium sport

\$451.00

GXAXE230 Welded aluminium sport with Carbon Fibre

\$899.00

XE030 Screw on aluminium

\$212.00

XE050 Screw on carbon fibre

\$474.00

Sideguard Measurements

Sideguard length



mm in

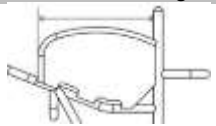

25mm above tyre
(Follow tyre)

Individual above tyre
(Follow tyre)



mm in

Level with tyre
(Follow tyre)

Sideguard height



mm in

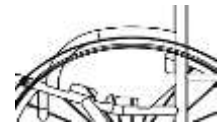
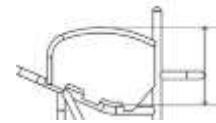

BACKREST

Backrest Height (Choose One)

XY230 Fixed backrest height



Specify height

mm in

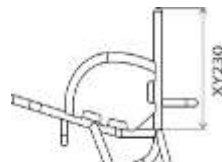

XY245 Adjustable backrest height
\$159.00 (+/-25mm)



Specify height

mm in

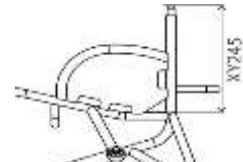

Ergonomic Options

XY360 Backrest angle

-5 -3 0 +3 +5



Individual
(Max -10/+10 Deg)

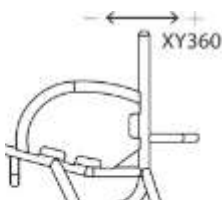

XG100 Ergonomic backrest
\$96.00



Vertical height

mm in



Rearward position

mm in

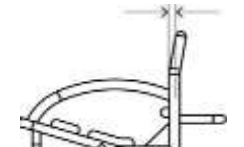

XG110 Inward taper
\$96.00 (inside of backrest posts)

Specify width / per side



mm in

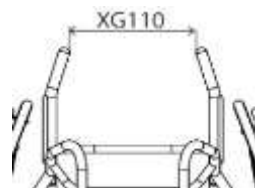

XG120 Outward flare
\$96.00 (inside of backrest posts)



Specify width / per side

mm in



CASTORS AND REAR WHEELS								
Castor Options								
XC160	Sport 61mm castor <i>(Std, Black)</i>			XC181	Bones Reds bearings <i>(All castor bearings)</i>			
XC170	Sport 72mm castor <i>(Black)</i>			XC182	Bones Swiss Ceramic bearings <i>(All castor bearings)</i>			
				\$335.00				
Rear Wheel Size								
XY420	24" Wheels		XY430	25" Wheels		XY440	26" Wheels	
						XY450	700C Wheels	
Rear Wheel Gap								
XY460	Rear wheel gap			XY470	Inside to inside of wheel			
	15	20	25	30		mm	in	
<i>Individual</i>	mm		in		NOTE: REQUIRED FOR V SEAT AND TAPER			
				OR				
Rear Wheel Options								
XK080	Spinergy SLX 24 spoke \$902.00			XK100	Spinergy XSLX 24 spoke \$951.00			
Spinergy Colour Options:								
Black spokes	White spokes	Yellow spokes	XK180	Individual spoke design \$211.00 <i>(Specify colour)</i>				
Red spokes	Blue spokes	Pink spokes	<i>Inside:</i>					
Purple spokes	Orange spokes	Green spokes	<i>Outside:</i>					
Spinergy Anodise Options								
XK190	Black hub <i>(std option)</i>	XK200	Silver hub \$110.00	XK201	Red hub/rims \$329.00	XK205	Individual hub/rims \$395.00 Select colour:	
XK202	Purple hub/rims \$329.00	XK203	Blue hub/rims \$329.00	XK204	Gold hub/rims \$329.00			
Supply Without Wheels								
XK040	Supply without Wheels -\$222.00							
Handrim Position / Options								
XY480	Narrow set handrim			XY485	Wide set handrim			
XL090	Remove excess mounting tabs \$122.00 <i>(recommended for small wheel gaps)</i>			XL080	Super narrow set handrim \$244.00 <i>(only with XL040 and includes XL090)</i>			
Handrim Style								
XL010	Aluminium hard anodised 6 tab <i>(Select Colour)</i>			XL040	Titanium 6 tab \$289.00 <i>(Not with 700C)</i>			
XL130	Aluminium hard anodised 6 tab Painted \$81.00 <i>(Select Colour)</i>			XL100	Para grip 6 tab \$341.00 <i>(Not with 700C)</i>			
XL070	Aluminium hard anodised 12 tab \$122.00 <i>(24" not available)</i>			XL020	Tetra Grip 6 tab \$341.00			
Tyre Options								
XM070	Kenda Kaliente	Red	Blue	XM095	Kenda Wide \$43.00 <i>(Grey Only)</i>			
XM150	IRC Exeracer Pro \$100.00 <i>(Red Only)</i>							
XM080	Tufo MS3 tubeless \$100.00 <i>(Blue only)</i>							
Spare Wheel								
GXAXK500	Spare wheel Spinergy \$1,017.00 <i>(Built up + axle pin)</i>			XK523	Spare wheel upcharge - Individual Hubs/Rims \$147.00			
XK520	Spare wheel upcharge - Titanium Rims \$236.00			XK524	Spare wheel upcharge - Individual Spoke Colour \$106.00			
XK522	Spare wheel upcharge - Remove Excess Tabs \$62.00							
Inner Tube Valve Options								
XY500	Schraeder inner tube valve 			XY490	Presta inner tube valve (Standard if no option selected) 			

FINISH OPTIONS

XN010 Powder coated frame

Frame Comp

Gloss

Black gloss 103

White gloss 100

Grey gloss 132

Cream gloss 135

Red gloss 108

Yellow gloss 120

Forest green gloss 143

Green gloss 107

Dark blue gloss 151

Royal blue gloss 154

Blue gloss 174

Duckegg blue gloss 141

Pink gloss 188

Orange gloss 180

Purple gloss 157

Frame Comp

Matt

Black matt 105

White matt 101

Grey matt 131

Light grey matt 133

Navy blue matt 152

Frame Comp

Special

Chrome Mirror 300

Sparkle silver 170

Metallic black matt 104

Metallic grey matt 130

Black sandpaper 201

Grey sandpaper 202

White sandpaper 200

XN200 Individual paint colour (State Colour/RAL code)
\$197.00

Frame Comp

GXAXN030 Brushed frame
\$398.00

XN160 Brushed components
\$151.00
(not required with fixed footrest & backrest)

GXAXN050 Polished frame
\$1,054.00

XN170 Polished components
\$222.00
(not required with fixed footrest & backrest)

Accent Colour (Choose One)

Note: Accent colour includes, forks, castor caps, decals.



Black accent

Silver accent

XN250
\$197.00

Individual accent

Red accent

Blue accent

Purple accent

Carbon accent
(caps only, black for others)

UPHOLSTERY

Seat Upholstery

GXAXP040 Seat sling strap adjustable
(not required with seatplate)

No seat sling (Seat Plate)

Backrest Upholstery



GXAXP055 Airtech sport backrest strap adjustable

XP070 Backrest upgrade to leather corners
\$137.00 (Black)

Backrest Stitching Options

Silver Black Blue Individual:

Red Orange Purple

Backrest RGK Logo Colour

White (Std) Green Blue Individual:

Red Orange Purple

Backrest Accessories

XP170 Individual backrest embroidery
\$156.00 PLEASE COMPLETE PAGE 9

CUSHION							
Cushion Foam Options							
XP080 \$96.00	Cushion foam <i>(select density and size below)</i>	Soft (CMS040)	Medium (CMS050)				
		50mm	75mm	100mm	Other	mm	in
XP340 \$89.00	Hard Plastazote cushion upgrade <i>(Indicate max height)</i>	580mm	630mm				
Cushion Cover Options							
XP085	Nylon cushion cover <i>(Black)</i>						
XP090 \$74.00	Air Lite cushion cover <i>(Black)</i>			XP380 \$102.00	Neoprene cushion cover <i>(Black)</i>		
STRAPPING							
Velcro straps				Ratchet Straps			
XS050 \$136.00	100mm Pro adjustable velcro strap			XS020 \$93.00	Sport ratchet strap (Click strap) <i>(11" x 2" pad)</i>		
XS055 \$136.00	50mm Pro adjustable velcro strap			XS021 \$94.00	Sport ratchet strap (Single)		
XS057 \$136.00	50mm Pro knee strap <i>(measurement from tube to tube over knees)</i>			XS025 \$232.00	Pelvi Loc 2DA ratchet strap <i>(For thighs and knees)</i>		
Velcro strap position							
Strap 1							
Specify strap length		Specify distance from back post					
mm	in	mm	in				
Strap 2							
Specify strap length		Specify distance from back post					
mm	in	mm	in				
				<div style="display: flex; justify-content: space-between;"> <div> <p>XS030 \$260.00</p> <p>Pelvi Loc 3DA ratchet strap <i>(For hips)</i></p> <p>i Select size:</p> <p>Medium (12") Large (14")</p> </div> <div> <p>XS035 \$155.00</p> <p>M2 ratchet strap <i>(For thighs and knees)</i></p> <p>i 8" 10" 12"</p> </div> </div>			
				<div style="display: flex; justify-content: space-between;"> <div> <p>XS036 \$155.00</p> <p>M2 ratchet strap (Single) <i>(For Feet)</i></p> <p>i 8" 10" 12"</p> </div> </div>			
				<div style="display: flex; justify-content: space-between;"> <div> <p>XS040 \$97.00</p> <p>Fixed mounting points <i>(one set per click strap)</i></p> <p>x1 x2 x3</p> </div> <div> <p>XS045 \$97.00</p> <p>Clamped mounting points <i>(one set per click strap)</i></p> <p>x1 x2 x3</p> </div> </div>			
FRAME OPTIONS							
XR060 \$115.00	Calf strap mounting loops			XR065 \$115.00	Strap location loops		
ACCESSORIES							
XR030 \$113.00	Triple wheel bag <i>(Black)</i>			XS070	Foot strap <i>(select if required)</i>		
XP130 \$104.00	Frame protectors full length			XS060	Calf strap <i>(select if required)</i>		
XS100 \$104.00	Bodypoint waist strap	Small	Large	XP400	Back bar protector		
				XR090	Tool kit		

ADDITIONAL NOTES

INDIVIDUAL BACKREST EMBROIDERY

PLEASE PROVIDE JPEG IMAGE AT TIME OF ORDER AND NOTE POSITION AND COLOUR BELOW



BRACE BAR

SPEC NOTES:

OFF SPEC REQUEST* (please specify below the page number(s) and details to which the off spec request applies.

OFF SPEC REQUEST APPROVED (for internal RGK office only)

X RGK Internal Sign-off

Off spec requests require a feasibility study which may increase order price and lead time. Any dimension/ option/ frame request not listed on the order form will be treated as an off spec request.*

Estimated MSRP*