

SERIAL NO: _____

AI
ALUMINIUM 7020



CE

Customer Contact Details

Customer Name: _____

Advisor: _____

Address: _____

Phone: _____

Email: _____

Ship to Customer Address:

Shipping Name: _____

Shipping Address: _____

Phone: _____

Email: _____

Additional Information

Notes: _____

Current Wheelchair: _____

Customer Weight: _____

Customer Height: _____

Customer Disability: _____

Other

VAT Exemption Declaration (UK Only):
 I declare that I am chronically sick or disabled by reason of:

 and that I am receiving from RGK Wheelchairs Ltd, the wheelchair specified herein and I claim relief from Value Added Tax under group 12 of schedule 8 to Value Added Tax Act 1994.
 Signature: _____ Date: _____

RGK Contact Authorisation:
 From time to time, RGK would like to send you exclusive information, news and offers on everything RGK, by email or post. We will not pass any of your details to any third party.
 I would like to be contacted by RGK:
 Signature: _____ Date: _____

SERIAL NO: _____

Guide:



Base product



Required option



Optional Extra



Critical Information



Information Needed

PRODUCT STYLE

GXAXZ010 GRANDSLAM X
\$5,757.00

Max User Weight 125kg (275lbs)

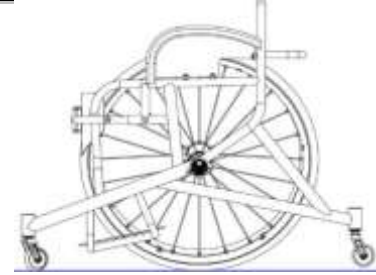

PLEASE NOTE: ALL RGK CHAIRS ARE HAND BUILT AND HAVE A MANUFACTURING MEASUREMENT TOLERANCE OF +/- 5MM

CAD APPROVAL

CAD approved by: Customer RGK Genius

XW009 QUOTE ONLY (NO CAD FOR APPROVAL)
\$0.00

XW011 ORDER (NO CAD FOR APPROVAL)
\$0.00

XW012 QUOTE CAD drawing for approval
\$421.00 (2 customer amendments ONLY)

XW010 ORDER CAD drawing for approval
\$260.00 (2 customer amendments ONLY)

KEY MEASUREMENTS

XY010 Seat width (*Inside to inside of sideguards*)
 mm in (*Max - 500mm*)

XY020 Seat length
 mm in (*Max - 500mm*)

XY030 Extra seat length (*not required with Knee support*)

mm in

XY050 Front frame height
 mm in (*Max - 630mm*)
(Min - 360mm)

XY060 Rear frame height
 mm in (*Max - 630mm*)
(Min - 360mm)

XY070 Frame length
 mm in (*Min XY020 + XY030 + 110mm*)

XA020 Ergonomic seat
 \$84.00
Specify length
 mm in (*Standard = 120mm*)

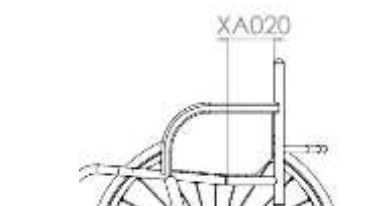
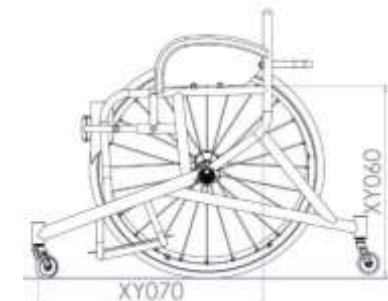
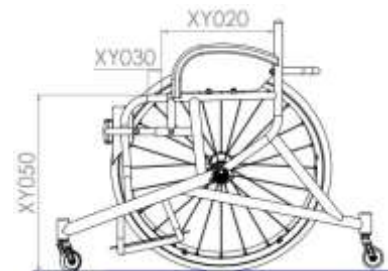
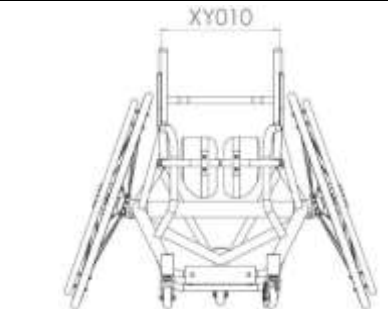

FRAME OPTIONS

Front Frame Options (Choose One)

XY080 Seat taper design



Specify taper width

mm in

(Optional, to provide additional leg support / positioning)



XA130 V-seat design

\$222.00



Specify taper width

mm in

NOTE: INSIDE TO INSIDE WHEEL (XY470) REQUIRED

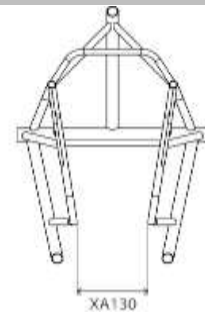

XA136 Frame front seat parallel design

\$87.00



Specify width

mm in

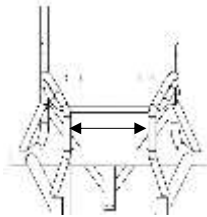

XA131 V-seat and Seat Taper Design

\$300.00

Specify inside width at front of sideguard (A)

mm in

Specify taper width (B)

mm in

NOTE: INSIDE TO INSIDE WHEEL (XY470) REQUIRED

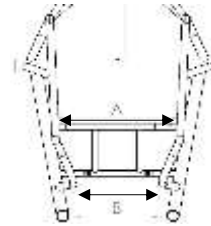

Knee Support Options

XA200 Knee support ratchet system
(Tubes on the **outside** as std)



Specify length

mm in

Optimise (Smallest)

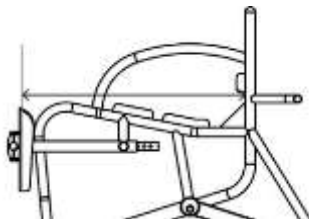

XA202 Plastic shin pads
(Includes 5mm padding)

XA203 Carbon fibre shin pads
(Includes 7mm hard padding)

XA204 Extra padding for shin pads
\$88.00

mm in



Specify padding thickness

mm in

Specify padding density

Medium Hard

Seat Options

XR040 Aluminum seat plate
\$139.00 (riveted to frame)



Specify length of plate

mm in (Std XY020 - 20mm)

XR050 Carbon fibre seat plate
\$354.00 (riveted to frame)



Specify length of plate

mm in (Std XY020 - 20mm)

FOOTREST

Footrest Type

■ GXAXB080 Fixed position footrest

Footrest Measurements

Front footrest height

mm in

(min = 35mm)

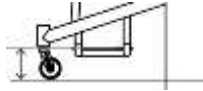

Footrest width

mm in

(Std= 200mm)

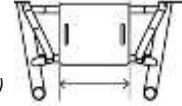

Rear footrest height

mm in

(min = 35mm)



Footrest length

mm in

(Std = 250mm)



Footrest position

(front of footplate to castor pot)

mm in

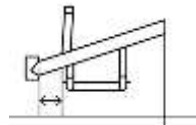

Footrest Plate

XB180 Aluminium footplate
(2.5mm)

GXAXB140 Spacer kit
\$19.00 (Allows for 25mm increase in height)

XB190 Carbon fibre footplate
\$230.00

XB100 ABS moulded foot tray
\$135.00

Specify length



mm in

Max = 380mm (Full)
Std = 330mm

Footrest Plate Options

XB240 Aluminium raised edges
\$79.00 (Cost per Edge)

XB250 Carbon Fibre raised edge
\$305.00 (1 side only)

Front Back Left Right

Front Back

Specify height

mm in

(Max = 60mm)

Specify height

mm in

(Max = 45mm)

Castor Pin Width

■ XY330 Castor pin width



mm in

Optimise measurements

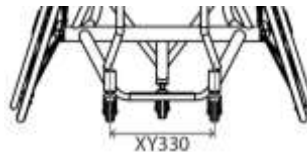

CAMBER BAR, WING AND ANTI-TIP

Centre of Gravity

GXAXY510 Fixed centre of gravity



Specify measurement

mm in

(Note: dimension is taken from front of backrest post to centre of

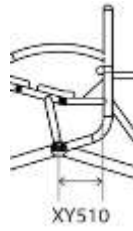

Camber Angle & Anti Tip

XY390 Camber angle



18 20 22

GXAXJ040 Single fixed anti tip



Specify distance behind rear wheel

mm in

(Std = 100mm)



SIDEGUARDS

Sideguard Style

GXAXE240 Welded aluminium sport
\$393.00

GXAXE230 Welded aluminium sport with Carbon Fibre
\$775.00

XE030 Screw on aluminium
\$185.00

XE050 Screw on carbon fibre
\$413.00

Sideguard Measurements

Sideguard length



mm in

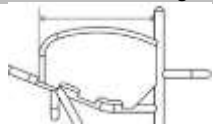

25mm above tyre
(Follow tyre)

Individual above tyre
(Follow tyre)



mm in

Level with tyre
(Follow tyre)

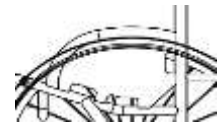

Sideguard height



mm in



BACKREST

Backrest Height (Choose One)

XY230 Fixed backrest height



Specify height

mm in

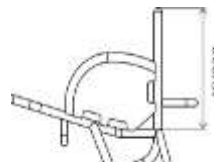

XY245 Adjustable backrest height
\$139.00 (+/-25mm)



Specify height

mm in

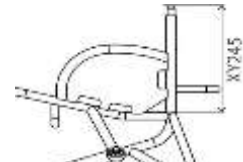

Ergonomic Options

XY360 Backrest angle

-5 -3 0 +3 +5



Individual

(Max -10/+10 Deg)

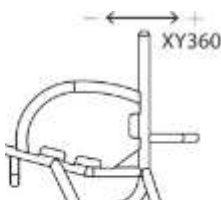

XG100 Ergonomic backrest
\$84.00



Vertical height

mm in



Rearward position

mm in



XG110 Inward taper
\$84.00
(inside of backrest posts)

Specify width / per side



mm in

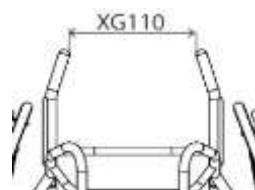

XG120 Outward flare
\$84.00
(inside of backrest posts)



Specify width / per side

mm in



CASTORS AND REAR WHEELS											
Castor Options											
	XC160	Sport 61mm castor <i>(Std, Black)</i>				XC181	Bones Reds bearings <i>(All castor bearings)</i>				
	XC170	Sport 72mm castor <i>(Black)</i>				XC182	Bones Swiss Ceramic bearings <i>(All castor bearings)</i>				
						\$292.00					
Rear Wheel Size											
	XY420	24" Wheels		XY430	25" Wheels		XY440	26" Wheels		XY450	700C Wheels
Rear Wheel Gap											
	XY460	Rear wheel gap				XY470	Inside to inside of wheel				
	15	20	25	30			mm	in			
<i>Individual</i>		mm		in		OR			NOTE: REQUIRED FOR V SEAT AND TAPER		
Rear Wheel Options											
	XK080	Spinergy SLX 24 spoke				XK100	Spinergy XSLX 24 spoke				
	\$787.00					\$829.00					
Spinergy Colour Options:											
	Black spokes	White spokes	Yellow spokes			XK180	Individual spoke design <i>(Specify colour)</i>				
	Red spokes	Blue spokes	Pink spokes								
	Purple spokes	Orange spokes	Green spokes								
Spinergy Anodise Options											
	XK190	Black hub <i>(std option)</i>		XK200	Silver hub		XK201	Red hub/rims		XK205	Individual hub/rims
				\$96.00			\$287.00			\$332.00	Select colour:
	XK202	Purple hub/rims		XK203	Blue hub/rims		XK204	Gold hub/rims			
	\$287.00			\$287.00			\$287.00				
Supply Without Wheels											
	XK040	Supply without Wheels									
	-\$193.00										
Handrim Position / Options											
	XY480	Narrow set handrim				XY485	Wide set handrim				
	XL090	Remove excess mounting tabs <i>(recommended for small wheel gaps)</i>				XL080	Super narrow set handrim <i>(only with XL040 and includes XL090)</i>				
	\$106.00					\$213.00					
Handrim Style											
	XL010	Aluminium hard anodised 6 tab				XL040	Titanium 6 tab <i>(Not with 700C)</i>				
						\$252.00					
	XL130	Aluminium hard anodised 6 tab Painted <i>(Select Colour)</i>				XL100	Para grip 6 tab <i>(Not with 700C)</i>				
	\$70.00					\$297.00					
	XL070	Aluminium hard anodised 12 tab <i>(24" not available)</i>				XL020	Tetra Grip 6 tab				
	\$106.00					\$297.00					
Tyre Options											
	XM070	Kenda Kaliente	Red	Blue		XM095	Kenda Wide <i>(Grey Only)</i>				
						\$37.00					
	XM150	IRC Exeracer Pro <i>(Red Only)</i>									
	\$87.00										
	XM080	Tufo MS3 tubeless <i>(Blue only)</i>									
	\$87.00										
Spare Wheel											
	GXAXK500	Spare wheel Spinergy <i>(Built up + axle pin)</i>				XK523	Spare wheel upcharge - Individual Hubs/Rims				
	\$887.00					\$128.00					
	XK520	Spare wheel upcharge - Titanium Rims				XK524	Spare wheel upcharge - Individual Spoke Colour				
	\$206.00					\$92.00					
	XK522	Spare wheel upcharge - Remove Excess Tabs									
	\$54.00										
Inner Tube Valve Options											
	XY500	Schraeder inner tube valve				XY490	Presta inner tube valve <i>(Standard if no option selected)</i>				

FINISH OPTIONS

XN010 Powder coated frame

Frame Comp	<u>Gloss</u>	Frame Comp	<u>Matt</u>	Frame Comp	<u>Special</u>
					Chrome Mirror 300
	White gloss 100		White matt 101		Sparkle silver 170
					White sandpaper 200

XN200 Individual paint colour (State Colour/RAL code) *Frame Comp*
\$180.00

GXAXN030 Brushed frame
\$365.00

XN160 Brushed components
(not required with fixed footrest & backrest)

GXAXN050 Polished frame
\$965.00

XN170 Polished components
(not required with fixed footrest & backrest)

Accent Colour (Choose One)

Note: Accent colour includes, forks, castor caps, decals.



Black accent	Silver accent	XN250 Individual accent
Red accent	Blue accent	\$180.00
Purple accent	Carbon accent <i>(caps only, black for others)</i>	

UPHOLSTERY

Seat Upholstery

GXAXP040 Seat sling strap adjustable <i>(not required with seatplate)</i>	No seat sling (Seat Plate)
--	----------------------------

Backrest Upholstery

GXAXP055 Airtech sport backrest strap adjustable	XP070 Backrest upgrade to leather corners \$126.00 <i>(Black)</i>
--	---

Backrest Stitching Options





Silver	Black	Blue	Individual:
Red	Orange	Purple	

Backrest RGK Logo Colour

White (Std)	Green	Blue	Individual:
Red	Orange	Purple	

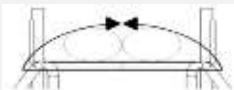
Backrest Accessories

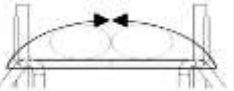
XP170 Individual backrest embroidery
\$143.00 PLEASE COMPLETE PAGE 9

CUSHION									
Cushion Foam Options									
XP080 \$88.00	Cushion foam <i>(select density and size below)</i>								
	Soft (CMS040)	Medium (CMS050)							
	50mm	75mm	100mm	Other	mm	in			
XP340 \$82.00	Hard Plastazote cushion upgrade <i>(Indicate max height)</i>		580mm	630mm					
Cushion Cover Options									
XP085	Nylon cushion cover <i>(Black)</i>								
XP090 \$68.00	Air Lite cushion cover <i>(Black)</i>				XP380 \$93.00	Neoprene cushion cover <i>(Black)</i>			
STRAPS									
Velcro straps									
XS050 \$125.00	100mm Pro adjustable velcro strap								
XS055 \$125.00	50mm Pro adjustable velcro strap								
XS057 \$125.00	50mm Pro knee strap <i>(measurement from tube to tube over knees)</i>								
Velcro strap position									
<div style="display: flex; justify-content: space-between;"> <div style="width: 48%;"> <p>Strap 1</p>  <p>Specify strap length</p> <p>mm in</p> <p>Specify distance from back post</p> <p>mm in</p> </div> <div style="width: 48%;"> <p>Strap 2</p>  <p>Specify distance from back post</p> <p>mm in</p> </div> </div>									
<div style="display: flex; justify-content: space-between;"> <div style="width: 48%;"> <p>Strap 1</p>  <p>Specify strap length</p> <p>mm in</p> <p>Specify distance from back post</p> <p>mm in</p> </div> <div style="width: 48%;"> <p>Strap 2</p>  <p>Specify distance from back post</p> <p>mm in</p> </div> </div>									
XS020 \$85.00	Sport ratchet strap (Click strap) <i>(11" x 2" pad)</i>								
XS021 \$86.00	Sport ratchet strap (Single)								
XS025 \$222.00	Pelvi Loc 2DA ratchet strap <i>(For thighs and knees)</i>								
	<i>Select size:</i> Medium (12") Large (14")								
XS030 \$238.00	Pelvi Loc 3DA ratchet strap <i>(For hips)</i>								
	<i>Select size:</i> S (8") M (12") L (14") XL (17")								
XS035 \$142.00	M2 ratchet strap <i>(For thighs and knees)</i>								
	<i>Select size:</i> 8" 10" 12"								
XS036 \$142.00	M2 ratchet strap (Single) <i>(For Feet)</i>								
	<i>Select size:</i> 8" 10" 12"								
FRAME OPTIONS									
XR060 \$106.00	Calf strap mounting loops				XR065 \$106.00	Strap location loops			
ACCESSORIES									
XR030 \$104.00	Triple wheel bag <i>(Black)</i>								
XP130 \$95.00	Frame protectors full length								
XS100 \$95.00	Bodypoint waist strap		Small	Large	XP400	Back bar protector			
	XR090 Tool kit								

ADDITIONAL NOTES

INDIVIDUAL BACKREST EMBROIDERY

PLEASE PROVIDE JPEG IMAGE AT TIME OF ORDER AND NOTE POSITION AND COLOUR BELOW



BRACE BAR

SPEC NOTES:

OFF SPEC REQUEST* (please specify below the page number(s) and details to which the off spec request applies.)

OFF SPEC REQUEST APPROVED (for internal RGK office only)

X
RGK Internal Sign-off

Off spec requests require a feasibility study which may increase order price and lead time. Any dimension/ option/ frame request not listed on the order form will be treated as an off spec request.*

Estimated MSRP*