

Mark For: _____

Date: _____

Dealer Acct #: _____

Dealer: _____

Dealer Contact: _____

Dealer Address: _____

Dealer City: _____ ST: _____ ZIP: _____

Dealer Phone: () _____ Fax: () _____

Confirmation Email: _____

 Confirm Via: Fax Email

Submitting for:
 Quote

 Order

PO#: _____

ADDITIONAL SHIPPING INFORMATION

Ship To: _____

Attention: _____

Address: _____

Address: _____

Ship To City: _____ ST: _____ ZIP: _____

Ship To Phone: () _____ Fax: () _____

The **HCPCS CODES** herein are based on PDAC verification or interpretation of Medicare definitions and guidelines. Non-Medicare payers may accept alternative **HCPCS CODES**, including misc. codes to ensure access for their enrollees. The use of **HCPCS CODES** does not ensure coverage or payment.

Head Positioning - Use HCPCS Code E0955

Whitmyer headrests come unassembled. Please add item WHITASSY001 if the dealer would like parts assembled. This is a no charge option.

Note: For cover selection, L = Lycra and V = Dartex Reversed

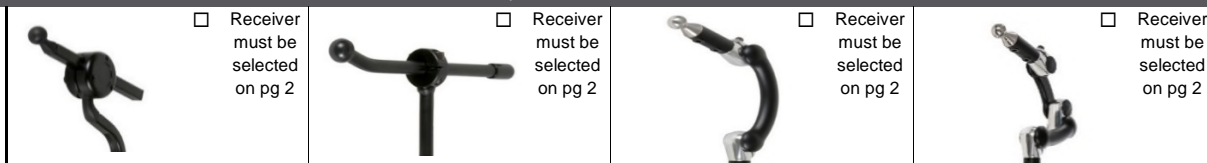

PAD		AXYS	ONYX	LINX	LINX ²
SINGLE SUB-OCCIPITAL	10" Pad Lrg OCC	<input type="checkbox"/> AXYS-SS10L \$437	<input type="checkbox"/> ONYX-SS10L \$437	<input type="checkbox"/> LINX-SS10L \$465	<input type="checkbox"/> LINX2-SS10L \$507
		<input type="checkbox"/> AXYS-SS10V \$437	<input type="checkbox"/> ONYX-SS10V \$437	<input type="checkbox"/> LINX-SS10V \$465	<input type="checkbox"/> LINX2-SS10V \$507
	6" Pad Lrg OCC	<input type="checkbox"/> AXYS-SS8L \$406	<input type="checkbox"/> ONYX-SS8L \$406	<input type="checkbox"/> LINX-SS8L \$443	<input type="checkbox"/> LINX2-SS8L \$483
		<input type="checkbox"/> AXYS-SS8V \$406	<input type="checkbox"/> ONYX-SS8V \$406	<input type="checkbox"/> LINX-SS8V \$443	<input type="checkbox"/> LINX2-SS8V \$483
	6" Pad Sml OCC	<input type="checkbox"/> AXYS-SS4L \$370	<input type="checkbox"/> ONYX-SS4L \$370	<input type="checkbox"/> LINX-SS4L \$406	<input type="checkbox"/> LINX2-SS4L \$448
		<input type="checkbox"/> AXYS-SS4V \$370	<input type="checkbox"/> ONYX-SS4V \$370	<input type="checkbox"/> LINX-SS4V \$406	<input type="checkbox"/> LINX2-SS4V \$448
ADULT DUAL SUB-OCCIPITAL	8" Pad Size 1 OCC	<input type="checkbox"/> AXYS-8L \$513	<input type="checkbox"/> ONYX-8L \$561	<input type="checkbox"/> LINX-8L \$530	<input type="checkbox"/> LINX2-8L \$572
		<input type="checkbox"/> AXYS-8V \$513	<input type="checkbox"/> ONYX-8V \$561	<input type="checkbox"/> LINX-8V \$530	<input type="checkbox"/> LINX2-8V \$572
	10" Pad Size 1 OCC	<input type="checkbox"/> AXYS-5L \$584	<input type="checkbox"/> ONYX-5L \$584	<input type="checkbox"/> LINX-5L \$553	<input type="checkbox"/> LINX2-5L \$595
		<input type="checkbox"/> AXYS-5V \$584	<input type="checkbox"/> ONYX-5V \$584	<input type="checkbox"/> LINX-5V \$553	<input type="checkbox"/> LINX2-5V \$595
	6" Pad Size 2 OCC	<input type="checkbox"/> AXYS-2L \$507	<input type="checkbox"/> ONYX-2L \$507	<input type="checkbox"/> LINX-2L \$489	<input type="checkbox"/> LINX2-2L \$530
		<input type="checkbox"/> AXYS-2V \$507	<input type="checkbox"/> ONYX-2V \$507	<input type="checkbox"/> LINX-2V \$489	<input type="checkbox"/> LINX2-2V \$530
PEDIATRIC DUAL SUB-OCCIPITAL	8" Pad Size 3 OCC	<input type="checkbox"/> AXYS-1L \$507	<input type="checkbox"/> ONYX-1L \$507	<input type="checkbox"/> LINX-1L \$489	<input type="checkbox"/> LINX2-1L \$530
		<input type="checkbox"/> AXYS-1V \$507	<input type="checkbox"/> ONYX-1V \$507	<input type="checkbox"/> LINX-1V \$489	<input type="checkbox"/> LINX2-1V \$530
	5" Pad Size 4 OCC	<input type="checkbox"/> AXYS-7L \$513	<input type="checkbox"/> ONYX-7L \$507	<input type="checkbox"/> LINX-7L \$530	<input type="checkbox"/> LINX2-7L \$572
		<input type="checkbox"/> AXYS-7V \$513	<input type="checkbox"/> ONYX-7V \$507	<input type="checkbox"/> LINX-7V \$530	<input type="checkbox"/> LINX2-7V \$572
	6" Pad Size 3 OCC	<input type="checkbox"/> AXYS-6L \$507	<input type="checkbox"/> ONYX-6L \$507	<input type="checkbox"/> LINX-6L \$489	<input type="checkbox"/> LINX2-6L \$530
		<input type="checkbox"/> AXYS-6V \$507	<input type="checkbox"/> ONYX-6V \$507	<input type="checkbox"/> LINX-6V \$489	<input type="checkbox"/> LINX2-6V \$530
CUDDLES INFANT	6" Pad Size 3 OCC	<input type="checkbox"/> AXYS-4L \$507	<input type="checkbox"/> ONYX-4L \$507	<input type="checkbox"/> LINX-4L \$489	<input type="checkbox"/> LINX2-4L \$530
		<input type="checkbox"/> AXYS-4V \$507	<input type="checkbox"/> ONYX-4V \$507	<input type="checkbox"/> LINX-4V \$489	<input type="checkbox"/> LINX2-4V \$530
	5" Pad Size 3 OCC	<input type="checkbox"/> AXYS-3L \$507	<input type="checkbox"/> ONYX-3L \$507	<input type="checkbox"/> LINX-3L \$489	<input type="checkbox"/> LINX2-3L \$530
		<input type="checkbox"/> AXYS-3V \$507	<input type="checkbox"/> ONYX-3V \$507	<input type="checkbox"/> LINX-3V \$489	<input type="checkbox"/> LINX2-3V \$530
	<input type="checkbox"/> AXYS-INFT \$390	<input type="checkbox"/> ONYX-INFTL \$390	N/A		

Head Positioning - Use HCPCS Code E0955

Whitmyer headrests come unassembled. Please add item WHITASSY001 if the dealer would like parts assembled. This is a no charge option.



Receiver must be selected at bottom of page



Adult - 15"
 Peds - 11"
 EI - 10"



Adult - 15"
 Peds - 11"
 EI - 10"

PAD		PRO		COBRA		COBRA-FB	
SINGLE SUB-OCCIPITAL	10" Pad Lrg OCC	<input type="checkbox"/>	PRO-SS10L \$507	<input type="checkbox"/>	COBRA-SS10L \$744	<input type="checkbox"/>	FB-COBRA-SS10L \$861
	6" Pad Lrg OCC	<input type="checkbox"/>	PRO-SS10V \$507	<input type="checkbox"/>	COBRA-SS10V \$744	<input type="checkbox"/>	FB-COBRA-SS10V \$861
	6" Pad Sml OCC	<input type="checkbox"/>	PRO-SS8L \$494	<input type="checkbox"/>	COBRA-SS8L \$730	<input type="checkbox"/>	FB-COBRA-SS8L \$849
	5" Pad Sml OCC	<input type="checkbox"/>	PRO-SS8V \$494	<input type="checkbox"/>	COBRA-SS8V \$730	<input type="checkbox"/>	FB-COBRA-SS8V \$849
ADULT DUAL SUB-OCCIPITAL	8" Pad Size 1 OCC	<input type="checkbox"/>	PRO-SS4L \$424	<input type="checkbox"/>	COBRA-SS4L \$659	<input type="checkbox"/>	FB-COBRA-SS4L \$778
	10" Pad Size 1 OCC	<input type="checkbox"/>	PRO-SS4V \$424	<input type="checkbox"/>	COBRA-SS4V \$659	<input type="checkbox"/>	FB-COBRA-SS4V \$778
	6" Pad Size 2 OCC	<input type="checkbox"/>	PRO-SS3L \$424	<input type="checkbox"/>	COBRA-SS3L \$659	<input type="checkbox"/>	FB-COBRA-SS3L \$778
	6" Pad Size 1 OCC	<input type="checkbox"/>	PRO-SS3V \$424	<input type="checkbox"/>	COBRA-SS3V \$659	<input type="checkbox"/>	FB-COBRA-SS3V \$778
PEDIATRIC DUAL SUB-OCCIPITAL	8" Pad Size 1 OCC	<input type="checkbox"/>	PRO-8L \$608	<input type="checkbox"/>	COBRA-8L \$843	<input type="checkbox"/>	FB-COBRA-8L \$960
	10" Pad Size 1 OCC	<input type="checkbox"/>	PRO-8V \$608	<input type="checkbox"/>	COBRA-8V \$843	<input type="checkbox"/>	FB-COBRA-8V \$960
	6" Pad Size 2 OCC	<input type="checkbox"/>	PRO-5L \$608	<input type="checkbox"/>	COBRA-5L \$843	<input type="checkbox"/>	FB-COBRA-5L \$960
	6" Pad Size 1 OCC	<input type="checkbox"/>	PRO-5V \$608	<input type="checkbox"/>	COBRA-5V \$843	<input type="checkbox"/>	FB-COBRA-5V \$960
	6" Pad Size 2 OCC	<input type="checkbox"/>	PRO-2L \$553	<input type="checkbox"/>	COBRA-2L \$789	<input type="checkbox"/>	FB-COBRA-2L \$907
	6" Pad Size 1 OCC	<input type="checkbox"/>	PRO-2V \$553	<input type="checkbox"/>	COBRA-2V \$789	<input type="checkbox"/>	FB-COBRA-2V \$907
	6" Pad Size 3 OCC	<input type="checkbox"/>	PRO-1L \$553	<input type="checkbox"/>	COBRA-1L \$789	<input type="checkbox"/>	FB-COBRA-1L \$907
	5" Pad Size 3 OCC	<input type="checkbox"/>	PRO-1V \$553	<input type="checkbox"/>	COBRA-1V \$789	<input type="checkbox"/>	FB-COBRA-1V \$907
PEDIATRIC DUAL SUB-OCCIPITAL	8" Pad Size 3 OCC	<input type="checkbox"/>	PRO-7L \$601	<input type="checkbox"/>	COBRA-7L \$837	<input type="checkbox"/>	FB-COBRA-7L \$954
	5" Pad Size 4 OCC	<input type="checkbox"/>	PRO-7V \$601	<input type="checkbox"/>	COBRA-7V \$837	<input type="checkbox"/>	FB-COBRA-7V \$954
	6" Pad Size 3 OCC	<input type="checkbox"/>	PRO-6L \$543	<input type="checkbox"/>	COBRA-6L \$778	<input type="checkbox"/>	FB-COBRA-6L \$896
	5" Pad Size 3 OCC	<input type="checkbox"/>	PRO-6V \$543	<input type="checkbox"/>	COBRA-6V \$778	<input type="checkbox"/>	FB-COBRA-6V \$896
	6" Pad Size 3 OCC	<input type="checkbox"/>	PRO-4L \$543	<input type="checkbox"/>	COBRA-4L \$778	<input type="checkbox"/>	FB-COBRA-4L \$896
	5" Pad Size 3 OCC	<input type="checkbox"/>	PRO-4V \$543	<input type="checkbox"/>	COBRA-4V \$778	<input type="checkbox"/>	FB-COBRA-4V \$896
		<input type="checkbox"/>	PRO-3L \$543	<input type="checkbox"/>	COBRA-3L \$778	<input type="checkbox"/>	FB-COBRA-3L \$896
		<input type="checkbox"/>	PRO-3V \$543	<input type="checkbox"/>	COBRA-3V \$778	<input type="checkbox"/>	FB-COBRA-3V \$896









Mounting Brackets - Use HCPCS Code E1028

Head Support System Mounting Brackets must be ordered separately, except for COBRA



	AXYS	ONYX	LINX & LINX ²	PRO	COBRA mounting system includes detachable mounting bracket
REMOVABLE MOUNTING BRACKET <small>(PART SOLD SEPARATELY FROM POST & PAD)</small>					
Detachable	<input type="checkbox"/> M2500S \$124	<input type="checkbox"/> M2100-WBS \$101	<input type="checkbox"/> M2300S \$194	<input type="checkbox"/> M2200-WBS \$218	
REMOVABLE & SWING-AWAY MNT BRACKET <small>(PART SOLD SEPARATELY FROM POST & PAD)</small>					
Swing-Away	<input type="checkbox"/> M5500 \$236	<input type="checkbox"/> M5100 \$218	<input type="checkbox"/> M5300 \$312	<input type="checkbox"/> M5200 \$336	

Lateral Facial Supports

Note: Cover Selection - Add L = Lycra or V = Dartex Reversed (Example: LFC-PLL)

								
	2"	2.25" x 5"	2.25" x 7"	4" x 6"	2" x 6"	1.75" x 5"	1.25" x 4"	
	SPOT	STANDARD	LONG	OVAL	LARGE-C	MED-C	SMALL-C	FSO-8
Unilateral	<input type="checkbox"/> LFC10L \$218 LM115S \$94	<input type="checkbox"/> LFC15L \$218 LM115S \$94	<input type="checkbox"/> LFC20L \$218 LM115S \$94	<input type="checkbox"/> LFC25L \$218 LM115S \$94	<input type="checkbox"/> LFC30L \$218 LM115S \$94	<input type="checkbox"/> LFC35L \$218 LM115S \$94	<input type="checkbox"/> LFC40L \$218 LM115S \$94	<input type="checkbox"/> LFC80 \$253 LM115S \$94
	<input type="checkbox"/> LFC10V \$218 LM115S \$94	<input type="checkbox"/> LFC15V \$218 LM115S \$94	<input type="checkbox"/> LFC20V \$218 LM115S \$94	<input type="checkbox"/> LFC25V \$218 LM115S \$94	<input type="checkbox"/> LFC30V \$218 LM115S \$94	<input type="checkbox"/> LFC35V \$218 LM115S \$94	<input type="checkbox"/> LFC40V \$218 LM115S \$94	
Bilateral	<input type="checkbox"/> LFC10L \$218	<input type="checkbox"/> LFC15L \$218	<input type="checkbox"/> LFC20L \$218	<input type="checkbox"/> LFC25L \$218	<input type="checkbox"/> LFC30L \$218	<input type="checkbox"/> LFC35L \$218	<input type="checkbox"/> LFC40L \$218	<input type="checkbox"/> LFC80 \$253 LM115S \$94
	<input type="checkbox"/> LFC10L \$218	<input type="checkbox"/> LFC15L \$218	<input type="checkbox"/> LFC20L \$218	<input type="checkbox"/> LFC25L \$218	<input type="checkbox"/> LFC30L \$218	<input type="checkbox"/> LFC35L \$218	<input type="checkbox"/> LFC40L \$218	
	<input type="checkbox"/> LM115S \$94	<input type="checkbox"/> LM115S \$94	<input type="checkbox"/> LM115S \$94	<input type="checkbox"/> LM115S \$94	<input type="checkbox"/> LM115S \$94	<input type="checkbox"/> LM115S \$94	<input type="checkbox"/> LM115S \$94	
	<input type="checkbox"/> LM115S \$94	<input type="checkbox"/> LM115S \$94	<input type="checkbox"/> LM115S \$94	<input type="checkbox"/> LM115S \$94	<input type="checkbox"/> LM115S \$94	<input type="checkbox"/> LM115S \$94	<input type="checkbox"/> LM115S \$94	
	<input type="checkbox"/> LFC10V \$218	<input type="checkbox"/> LFC15V \$218	<input type="checkbox"/> LFC20V \$218	<input type="checkbox"/> LFC25V \$218	<input type="checkbox"/> LFC30V \$218	<input type="checkbox"/> LFC35V \$218	<input type="checkbox"/> LFC40V \$218	
	<input type="checkbox"/> LFC10V \$218	<input type="checkbox"/> LFC15V \$218	<input type="checkbox"/> LFC20V \$218	<input type="checkbox"/> LFC25V \$218	<input type="checkbox"/> LFC30V \$218	<input type="checkbox"/> LFC35V \$218	<input type="checkbox"/> LFC40V \$218	
	<input type="checkbox"/> LM115S \$94	<input type="checkbox"/> LM115S \$94	<input type="checkbox"/> LM115S \$94	<input type="checkbox"/> LM115S \$94	<input type="checkbox"/> LM115S \$94	<input type="checkbox"/> LM115S \$94	<input type="checkbox"/> LM115S \$94	
	<input type="checkbox"/> LM115S \$94	<input type="checkbox"/> LM115S \$94	<input type="checkbox"/> LM115S \$94	<input type="checkbox"/> LM115S \$94	<input type="checkbox"/> LM115S \$94	<input type="checkbox"/> LM115S \$94	<input type="checkbox"/> LM115S \$94	
<input type="checkbox"/> PL10LS \$84	<input type="checkbox"/> PL15LS \$118	<input type="checkbox"/> PL20LS \$118	<input type="checkbox"/> P600LS \$118	<input type="checkbox"/> PL30LS \$118	<input type="checkbox"/> PL35LS \$118	<input type="checkbox"/> PL40L \$106	N/A	
<input type="checkbox"/> PL10VS \$84	<input type="checkbox"/> PL15VS \$118	<input type="checkbox"/> PL20VS \$118	<input type="checkbox"/> P600VS \$118	<input type="checkbox"/> PL30VS \$118	<input type="checkbox"/> PL35VS \$118	<input type="checkbox"/> PL40V \$106		

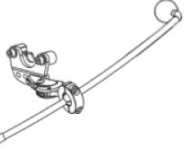
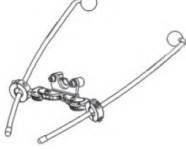
Lateral Facial Supports

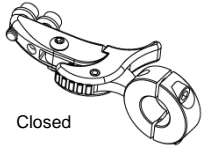
MOUNTING HARDWARE					
	Unilateral	Bilateral	Infinity Mount	Swing-Away Mount	LM115S

LATERAL FACIAL SUPPORT PARTS

*Note: If ordering an additional Lateral Facial Support, select both a Lateral Facial Support Pad Only from above and an Infinity Mount from below as well

✓	Option #	Definition	Price
<input type="checkbox"/>	242161	Infinity Dual Mount Assembly*	\$230
<input type="checkbox"/>	LM1010S	Lateral Facial Support*	\$148

ANTERIOR HEAD SUPPORT

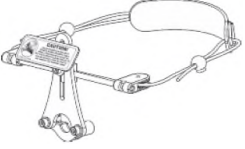
			
DYNAMIC FOREHEAD STRAP	DFS ²	STRAP CAP	STATIC FOREHEAD STRAP

ADULT	<input type="checkbox"/>	DFS10	\$341	<input type="checkbox"/>	DFSQ10S	\$412	<input type="checkbox"/>	CAP10 (black)	\$471	<input type="checkbox"/>	HU10	\$371
PEDS	<input type="checkbox"/>	DFS30	\$341	<input type="checkbox"/>	DFSQ30S	\$412	<input type="checkbox"/>	CAP30-R (red)	\$471			
	<input type="checkbox"/>			<input type="checkbox"/>			<input type="checkbox"/>	CAP30-B (blue)	\$471			

MOUNTING OPTIONS				
FLEX INTERFACE BRACKET	UNIVERSAL SWING-AWAY MOUNT	SLIDE MOUNT	PRO OFF-SET MOUNTING SYSTEM	ONYX REARWARD OFF-SET VERTICAL ROD
<input type="checkbox"/> M9450S(hard) \$218 <input type="checkbox"/> M9451 (soft) \$218	<input type="checkbox"/> M5000S \$118	<input type="checkbox"/> M7010S \$112	<input type="checkbox"/> PRC7070 \$192	<input type="checkbox"/> OX6030 \$71

TOOLS			
Option #	Definition	Price	
<input type="checkbox"/> BOLT LUBE	Bolt Lube	\$10.00	
<input type="checkbox"/> T2500S	Tool Kit	\$8.00	

Pad Styles				
SINGLE SUB-OCCIPITAL	10" Pad Large OCC SS10 PAD = 10"w X 5"h SUB OCC = 9"w X 3"h	6" Pad Large OCC SS8 PAD = 6"w X 4"h SUB OCC = 9"w X 3"h	6" Pad Small OCC SS4 PAD = 6"w X 4"h SUB OCC = 8"w X 2"h	5" Pad Small OCC SS3 PAD = 5"w X 2-1/4"h SUB OCC = 8"w X 2"h
ADULT DUAL SUB-OCCIPITAL	8" Pad Size 1 OCC 8 PAD = 8"w X 5"h SUB OCC = 8"w X 3"h	10" Pad Size 1 OCC 5 PAD = 10"w X 5"h SUB OCC = 8"w X 3"h	6" Pad Size 2 OCC 2 PAD = 6"w X 4"h SUB OCC = 4"w X 3"h	6" Pad Size 1 OCC 1 PAD = 6"w X 4"h SUB OCC = 8"w X 3"h
Pediatric DUAL SUB-OCCIPITAL	8" Pad Size 3 OCC PAD = 8"w X 5"h SUB OCC = 7"w X 2.5"h	5" Pad Size 4 OCC PAD = 5"w X 2-1/4"h SUB OCC = 4"w X 2.5"h	6" Pad Size 3 OCC PAD = 6"w X 4"h SUB OCC = 7"w X 2.5"h	5" Pad Size 3 OCC PAD = 5"w X 2-1/4"h SUB OCC = 7"w X 2.5"h
CUDDLES INFANT	INFT Pad Size 3 OCC PAD = 3.5"w X 1.5"h SUB OCC = 4"w X 1.75"h			



Sunrise Medical (US) LLC
 12002 Volunteer Blvd. · Mount Juliet, TN 37122 · USA

Customer Service: 800-333-4000 Fax: 800-300-7502 Email: orders@sunmed.com www.sunrisemedical.com

©1/2025 MK-129442 REV. J