

Quickie® Q700® M / Q700® M HD

Supplier: This manual must be given to the user of this wheelchair.

User: Before using this wheelchair read this entire manual and save for future reference.

Owner's Manual

Quickie® Q700® M / Q700® M HD

Distribuidor: Este manual debe ser entregado el usuario de esta silla de ruedas.

Usuario: Antes de usar esta silla de ruedas, lea este manual en su totalidad y guárdelo para futura referencia.

Manual de
Instrucciones

Cada una de las sillas se envía con un manual de instrucciones en inglés. El manual en español y francés está disponible en formato PDF en nuestra página en Internet: www.SunriseMedical.com. Ingrese a la página del producto específico para descargar el manual, o comuníquese con el proveedor autorizado de Sunrise Medical.

Quickie® Q700® M / Q700® M HD

Au Fournisseur: Ce manuel doit être remis à l'utilisateur de ce fauteuil roulant.

Utilisateur: Avant d'utiliser ce fauteuil roulant, lisez l'intégralité de manuel et conserver pour référence future.

Manuel
d'instructions

Chaque fauteuil est livré avec un manuel d'instructions en anglais. Les versions en espagnol et en français sont à votre disposition en format PDF sur le site : www.SunriseMedical.com. Veuillez vous rendre à la page de votre produit pour télécharger le manuel dans la langue souhaitée, ou contactez un fournisseur agréé Sunrise Medical.

P/N 247553 Rev. I

QUICKIE®
Q700® M / Q700® M HD
General Manual

Instructions for Use

SUNRISE MEDICAL LISTENS

Thank you for choosing a Quickie® wheelchair. We want to hear your questions or comments about this manual, the safety and reliability of your chair, and the service you receive from your Sunrise dealer. Please feel free to write or call us at the address and telephone number below:

SUNRISE MEDICAL (US) LLC
Customer Service Department
2842 N. Business Park Avenue
Fresno, CA 93727 USA
(800) 333-4000



www.SunriseMedical.com/register

Please register your wheelchair, and let us know if you change your address. This will allow us to keep you up to date with information about safety, new products, and options to increase your use and enjoyment of the wheelchair.

You can also register your product at:
www.SunriseMedical.com/register

FOR ANSWERS TO YOUR QUESTIONS

Your authorized dealer knows your wheelchair best, and can answer most of your questions about chair safety, use, and maintenance.

For future reference, please fill in the following:

Dealer: _____

Address: _____

Telephone: _____

Serial #: _____ Date/Purchased: _____

ADDITIONAL INFORMATION YOU SHOULD KNOW

No component of this chair was made with Natural Rubber Latex.



DISPOSAL AND RECYCLING INFORMATION

When this product reaches the end of its life, please take it to an approved collection or recycling point designated by your local or state government. This product is manufactured using a variety of materials.

Your product should not be disposed of as ordinary household waste. You should dispose of your product properly, according to local laws and regulations. Most materials that are used in the construction of this product are fully recyclable. The separate collection and recycling of your product at the time of disposal will help conserve natural resources and ensure that it is disposed in a manner that protects the environment.

Ensure you are the legal owner of the product prior to arranging for the product disposal in accordance with the above recommendations.

II. TABLE OF CONTENTS

1.0	User Information	4	6.0	Batteries, charging, and range.....	13
1.1	This user manual.....	4	6.1	Batteries.....	13
1.2	For further information.....	4	6.2	Charging batteries.....	14
1.3	Symbols used in this manual.....	4	6.3	The range of your vehicle.....	14
2.0	Safety.....	5	6.4	Replacing batteries.....	15
2.1	Symbols and labels used on the product.....	5	6.5	Disconnecting batteries for air transport.....	15
2.2	Safety: Temperature.....	5	7.0	Transportation	16
2.3	Safety: Moving parts.....	5	7.1	Transport of the wheelchair in a car.....	16
2.4	Safety: Electromagnetic radiation.....	5	7.2	The wheelchair as a passenger seat.....	17
2.5	Safety: Choking hazard.....	5	7.3	Special transit requirements.....	18
2.6	Safety: Using a (vehicle mounted) wheelchair lift.....	6	7.4	General transport warnings.....	18
2.7	Safety: Accessory trays.....	6	8.0	Maintenance and cleaning	19
2.8	Safety: Lifting the wheelchair	6	8.1	Maintenance	19
2.9	Safety: Stability.....	6	8.2	Wheels and tires maintenance.....	20
3.0	Intended use of the wheelchair.....	7	8.3	Lighting maintenance.....	21
3.1	Area of application: The user.....	7	8.4	Cleaning and disinfection.....	21
3.2	Area of application: The user environment.....	8	8.5	Medium to long term storage	21
4.0	Setting up the wheelchair	8	9.0	Trouble shooting	21
4.1	Seating system	8	10.0	Technical specifications: Applicable norms / standards	22
4.2	Seat height.....	8	11.0	Sunrise Limited Warranty.....	23
4.3	Center of gravity	8			
4.4	Controller height and depth	8			
4.5	Control system program	8			
4.6	Check after setup and/or adjustment of wheelchair.....	8			
5.0	Using the wheelchair.....	9			
5.1	Checking wheelchair before use.....	9			
5.2	Making a transfer.....	9			
5.3	Driving the wheelchair.....	9			
5.4	Curves.....	10			
5.5	Breaking and Emergency stop.....	10			
5.6	Driving on a slope.....	10			
5.7	When seated and driving in lift mode.....	10			
5.8	Obstacles and curbs.....	11			
5.9	Pushing the wheelchair	11			
5.10	(Powered) seating options	12			

Congratulations on choosing a Sunrise Medical wheelchair. Our high quality mobility products are designed to enhance your independence and make your everyday life easier.

As a part of our ongoing product improvement initiative, Sunrise Medical reserves the right to change specifications and design without notice. Further, not all features and options offered are compatible with all configurations of the wheelchair.

All dimensions are approximate and may be subject to change. The intended lifetime of the wheelchair is five (5) years. Please DO NOT use or fit any third party components to the wheelchair unless they are officially approved by Sunrise Medical.

1.1 This user manual

This user manual will help you to use and maintain your wheelchair safely. This entire user manual for this wheelchair consists of four booklets:

- The general wheelchair user manual (this booklet)
- The user manual for the seating system
- The user manual for the controller
- The user manual for the battery charger

When necessary, this general user manual refers to other manuals as shown below:

 Seating system: Refers to the user manual for the seating system.

 Controller: Refers to the user manual for the controller.

 Battery charger: Refers to the user manual for the battery charger.

Do not use your wheelchair until this entire manual (all booklets) has been read and understood!

If one of the user manuals was not included with your wheelchair, please contact your dealer immediately.

1.2 For further information

Please contact your local, Sunrise Medical authorized dealer if you have any questions regarding the use, maintenance, or safety of your wheelchair. In case there is no authorized dealer in your area or you have any questions, contact Sunrise Medical either in writing or by telephone. For information about product safety notices and product recalls, go to www.SunriseMedical.com

1.3 Symbols used in this manual

 **DANGER!**
Potential risk of serious injury or death

 **WARNING!**
Potential risk of injury

 **CAUTION!**
Potential damage to equipment

NOTE:
General user advice

Not following these instructions may result in physical injury, damage to the product or damage to the environment!

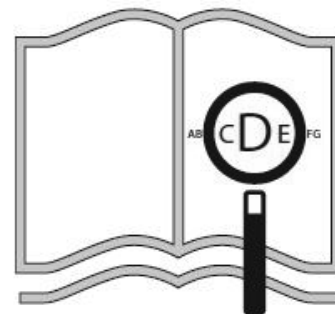

If you are visually impaired, this document can be viewed in PDF format at www.SunriseMedical.com



2.0 SAFETY

Follow the instructions carefully next to these warning symbols! Not paying careful attention to these instructions could result in physical injury or damage to the wheelchair or the environment. Wherever possible, safety information is provided in the relevant chapter.

2.1 Symbols and labels used on the product

The signs, symbols and instructions affixed to the wheelchair comprise part of the safety facilities. They must never be covered or removed. They must remain present and clearly legible throughout the entire lifespan of the wheelchair.

Replace or repair all illegible or damaged signs, symbols, and instructions immediately. Please contact your Sunrise Medical authorized dealer for assistance.

Fig. 2.1: Chair serial number: located on right side of the base on the top front of the battery box.

Fig. 2.2 Transit fixation point.

Fig. 2.3: Warning – Danger of finger entrapment (pinch point).

Fig. 2.4: Warning – Maximum user weight for the wheelchair.

Fig. 2.5: Location of Motor Serial Number Label.

Fig. 2.6: Warning – Hot Label on Motor.



Fig. 2.2



Fig. 2.3

2.2 Safety: Temperature



WARNING!

1. Avoid physical contact with the wheelchair's motors at all times. Motors are continuously in motion during use and can reach high temperatures. After use, the motors will cool down slowly. Physical contact could cause burns. Allow the motors after using at least 30 minutes to cool down.
2. If you do not use the wheelchair, ensure that it is not exposed to direct sunlight for lengthy periods of time. Certain parts of the wheelchair, such as the seat, the back, and the armrests can become hot if they have been exposed to full sunlight for too long. This may cause burns or allergic reactions to the skin.

2.3 Safety: Moving parts



DANGER!

A wheelchair has moving and rotating parts. Contact with moving parts may result in serious physical injury or damage to the wheelchair. Contact with the moving parts of the wheelchair should be avoided (Fig. 2.7).

- | | |
|-------------------------------------|---|
| 1. Wheels (turning and caster) | 4. Powered recline adjustment |
| 2. Powered tilt in space adjustment | 5. Swing-away bracket of the controller |
| 3. Powered seat lift option | 6. Power elevating leg rests |

2.4 Safety: Electromagnetic radiation



CAUTION!

The standard version of your electric wheelchair has been tested on the applicable requirements with respect to electromagnetic radiation (EMC requirements). In spite of these tests:

1. It cannot be excluded that electromagnetic radiation may have an influence on the wheelchair. For example:
 - a. Mobile telephones
 - b. Large-scale medical apparatus
 - c. Other sources of electromagnetic radiation
2. It cannot be excluded that the wheelchair may interfere with electromagnetic fields. For example:
 - a. Shop doors
 - b. Burglar alarm systems in shops
 - c. Garage door openers

In the unlikely event that such problems do occur, we request that you notify your Sunrise Medical authorized dealer immediately.



DANGER!

1. When operating two-way radio, walkie-talkies, C.B. radio, Amateur radio, public mobile radio, and other powerful transmitting devices the wheelchair should be brought to a halt and turned off.
2. The operation of cordless, mobile telephones, and cell phones including hands-free devices is permitted but if abnormal operation of the wheelchair is encountered then the chair must be brought immediately to a halt and turned off.

Controller: Refers to the user manual for the controller.

2.5 Safety: Choking hazard



DANGER!

This mobility aid uses small parts which under certain circumstances may present a choking hazard to young children.



Fig. 2.1



Fig. 2.4

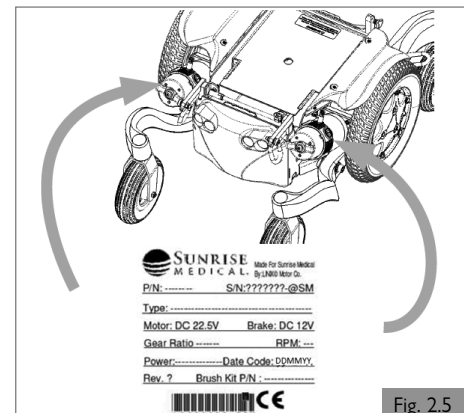

Fig. 2.5



Fig. 2.6

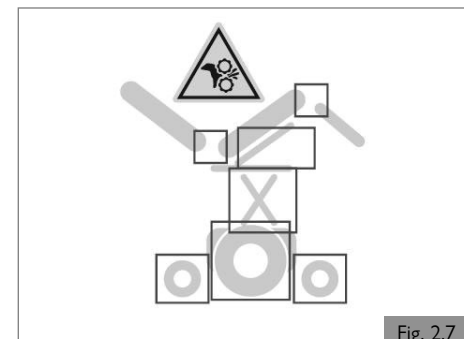

Fig. 2.7

2.6 Safety: Using a (vehicle mounted) wheelchair lift

Wheelchair lifts are used in vans, buses, and buildings to help you move from one level to another.

⚠ DANGER!

1. Ensure that the user and all caregivers fully understand the lift manufacturer's instructions for using the passenger lift.
2. Never exceed the lift manufacturer's recommended safe working load and load distribution guidance.
3. Always turn off all power when you are on the lift. If you fail to do so, you may touch the joystick by accident and cause your chair to drive off the platform. Be aware that a roll-stop at the end of the platform may not prevent this.
4. Always position the user securely in the chair to help avoid falls while on the lift.
5. Always ensure the chair is in drive mode when using passenger lift (wheels locked, not in freewheel mode).

2.7 Safety: Accessory Trays**Safety: Vent tray****⚠ DANGER!**

Using a vent tray will affect the stability and overall weight of your wheelchair.

1. Ensure that the batteries and the ventilator are securely fastened to the tray before use.
2. Familiarize yourself with the increased size of the wheelchair before driving to prevent potential collisions.
3. When activating the recline backrest ensure that the area around the vent tray is clear.
4. Be aware that the vent tray assembly can cause a finger trap hazard when the backrest is reclined.
5. The vent tray is not designed to hold anything other than the vent unit and its batteries; it is not designed to hold an oxygen bottle, etc. Use of these items may cause your wheelchair to become unstable.
6. The vent tray must be attached and maintained by a Sunrise Medical authorized dealer.

Safety: Swing away tray**⚠ DANGER!**

1. The maximum load allowed for the tray is 5.5 lbs (2.5 kg).
2. Do not overload the tray; this could cause the tray to break or could cause the chair to become unstable.
3. Do not leave lit cigarettes or other heat sources on the tray as this could cause the tray to deform and mark.
4. Ensure that all extremities and clothing are clear when positioning the tray for use.

2.8 Safety: Lifting the wheelchair**⚠ WARNING!**

Do not lift this seating system by any parts that are removable, doing so may result in damage to the seating system or injury to the user.

2.9 Safety: Stability**⚠ WARNING!**

1. Removing the batteries may cause the chair to become unstable causing it to tip backwards.
2. Only remove the batteries while the chair is on the ground.
3. Do not remove the batteries while the chair is on a lift table or on any other elevated surface.

3.0 INTENDED USE OF THE WHEELCHAIR

General description

The Q700® range is a modular power wheelchair. A distinctive feature is the suspension system that allows you to have a perfect driving experience indoors as well as outdoors.

3.1 Area of application: The user

Power wheelchairs are exclusively for a user who is unable to walk or has limited mobility, for their own personal use indoors and outdoors.

Driving a powered wheelchair requires cognitive, physical, and visual skills. The user must be able to estimate and correct the results of actions when operating the wheelchair.

The wheelchair cannot transport more than one person at a time. The maximum weight limit (includes both the user and any weight of accessories fitted to the wheelchair) is marked on the serial number label, which is affixed to the chair.

The overall maximum user weight shall not exceed:

Standard Base	- 300 lbs (136 kg)
Base with HD Seat	- 450 lbs (204 kg)
Base w/C-Me® up to 3mph	- 300 lbs (136 kg)
Power Recline	- 350 lbs (159 kg)

⚠ WARNING!

Exceeding the weight capacities could lead to injury and/or permanent damage to the equipment.

NOTE — Exceeding the weight limit will void the warranty.

The user must be informed of the contents of this user manual before driving the wheelchair.

Indications

The varieties of fitting variants, as well as the modular design, mean that it can be used by those who cannot walk or have limited mobility because of:

1. Paralysis
2. Loss of extremity (leg amputation)
3. Extremity defect/deformity
4. Joint contractures/joint injuries
5. Illnesses such as heart and circulation deficiencies, disturbance of equilibrium or cachexia as well as for elderly people who still have strength in the upper body.

Contraindications

The wheelchair shall not be used in case of:

1. Perception disorder
2. Imbalance
3. Seating disability

⚠ WARNING!

1. If you are under the influence of medicines that can have an effect on your ability to drive, you are not permitted to drive a wheelchair.
2. Adequate vision is required in order to safely operate a wheelchair in the user situation concerned.
3. Not more than one person at a time can be seated in the wheelchair.
4. Do not allow children to ride in the wheelchair unsupervised.

⚠ CAUTION!

The user of the wheelchair is at all times completely responsible for complying with the applicable local safety regulations and guidelines.

Attendants

When an attendant control module is fitted, the power wheelchair may be operated by an assistant on behalf of the user.

When a dual control module is fitted the power wheelchair may be operated by the user, or control may be switched to an assistant to operate on behalf of the user.

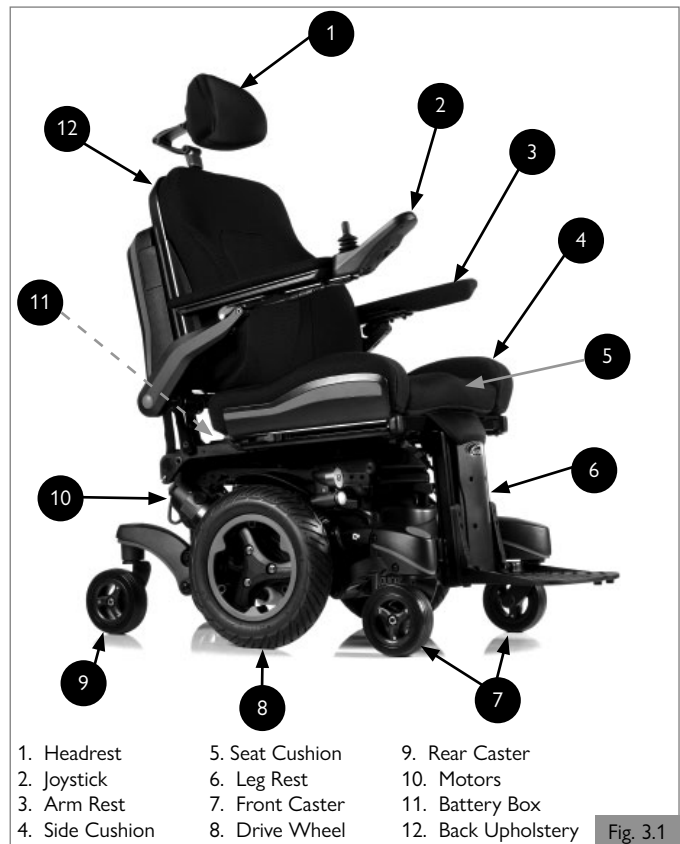

1. Ensure you heed all warnings and follow all instructions in each section of this manual. Warnings that apply to the user also apply to you.
2. Do not stand or sit on any portion of this seating system.
3. You need to work with the user, and the user's health care provider, to develop safe methods best suited to your abilities and those of the user.
4. Check to ensure push handle grips will not rotate or slip off.
5. Ensure you always have comfortable access to the attendant controls while the chair is moving and ensure that the controller is fitted securely to the chair.
6. Set the speed of the attendant control to a speed that you can comfortably follow.
7. Always turn off the power to the controller when leaving the user in the chair.

⚠ WARNING!

DO NOT use any wheelchair that has been involved in a motor vehicle accident. A sudden stop and/or collision may structurally damage your wheelchair. There may have been a change to the structure of the chair, and/or damaged or broken some of the components. Wheelchairs involved in sudden stops should be inspected for possible failures in frame and/or components. Frame damage may be represented by but not limited to: visual cracks, dents, metal distortion, bends, or damage to the seating mounting. If the chair no longer drives straight, it could be damaged.

If the wheelchair has been involved in an accident, discontinue use immediately and contact your Sunrise Medical authorized dealer for a thorough inspection. If damage is questionable or if there is concern regarding the condition of the chair, Sunrise Medical recommends replacement of the chair. Wheelchairs involved in collisions should be replaced.

NOTE — The warranty is void on any wheelchair that is involved in a collision.

3.0 INTENDED USE OF THE WHEELCHAIR

3.2 Area of application: The user environment (Fig. 3.2)

This wheelchair has been designed to accommodate both indoor and outdoor use (ANSI/RESNA WC-1:2009). When driving the wheelchair outdoors, drive only on paved roads, pavements, footpaths, and bicycle paths. The speed must be adapted to suit the environment.

⚠ WARNING!

1. Drive carefully on slippery roads resulting from rain, ice, or snow!
2. You are required to turn on the lights in case of limited visibility.
3. When driving at higher speeds you must be extra careful. Select a lower maximum speed indoors, on the pavement, and in pedestrian areas.
4. Do not drive off high obstacles.
5. Do not attach a weight to the wheelchair without the approval of a qualified specialist. This may negatively affect the stability of the product.

⚠ CAUTION!

1. Prevent the wheelchair from coming into contact with sea water: sea water is caustic and may damage the wheelchair.
2. Prevent the wheelchair from coming into contact with sand: sand can permeate into the moving parts of the wheelchair, causing extensive wear on these parts.
3. Do not use the wheelchair if temperatures are below: 15°F (-10°C) or above 120°F (+50°C).
4. Do not open doors using the leg rests.
5. Do not push and/or tow any objects with the wheelchair.
6. Do not drive through puddles of water.
7. Ensure the battery cover is secure.
8. Never take your chair into a shower, tub, pool, or sauna.
9. Dry the chair as soon as you can if it gets wet, or if you use water to clean it.

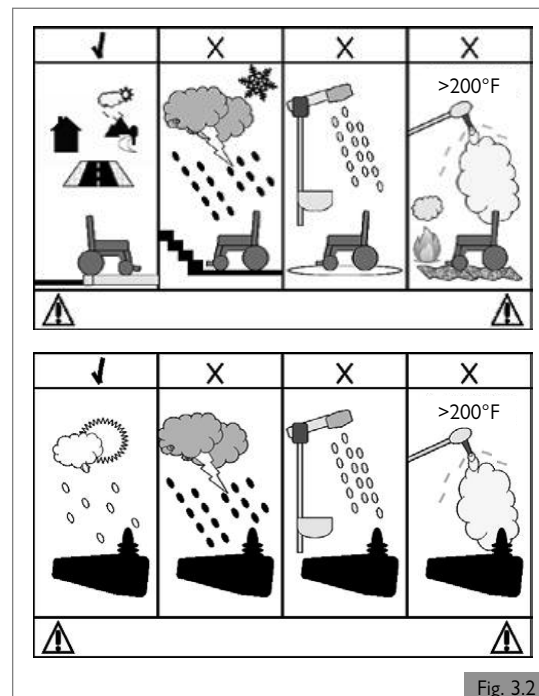

Fig. 3.2

4.0 SETTING UP THE WHEELCHAIR

The average wheelchair user does not exist. This is why Sunrise Medical wheelchairs can be adjusted according to specific needs of the user.

In this, we make a distinction between wheelchair settings and wheelchair seating adjustment options. Settings are carried out once, the first time the wheelchair is going to be used. They must be executed by a Sunrise Medical authorized dealer, unless explicitly stated otherwise. Some seating adjustment options can be carried out by the user. These adjustment options do not require the use of tools.

4.1 Seating system

The extensive settings with respect to the seating system allow for optimum support of the body. (Seating System)

The following setting options are possible:

1. Seat depth and seat width
2. Backrest angle
3. Armrest height
4. Lower leg length
5. Angle of the footplate

4.2 Seat height

Depending on the specific circumstances of the user of the wheelchair the seat height can be set. Every optional seat height lays within the maximum safe slope as described in (ISO 7176-1:2014). Lowering the seat height has a positive influence on the (dynamic) stability.

⚠ DANGER!

Increasing the seat height has a negative effect on dynamic stability.

4.3 Center of gravity

⚠ DANGER!

Adjusting the center of gravity on a powered wheelchair is both physically demanding and safety critical. Sunrise Medical strongly recommends that this adjustment is only performed by a Sunrise Medical authorized dealer.

4.4 Controller height and depth

(Seating system)

4.5 Control system program

This wheelchair is equipped with a control system that can be programmed by adjusting settings within the system. This is a specialized job that needs training and can only be adjusted with professional software. It is not possible and not allowed for end users to adjust these settings

⚠ DANGER!

The incorrect setting of the parameters for the control system may result in very dangerous situations. Settings must be made by a Sunrise Medical authorized dealer.

4.6 Check after setup and/or adjustment of wheelchair

After the initial setup by the Sunrise Medical authorized dealer or after making any adjustments to the wheelchair a check to confirm that no interferences exist must be completed.

Interferences can happen (but not limited to) adjustments to the joystick, armrest, specialty control mounts, leg rest, headrest, etc. After an adjustment has been made, the movement of that device may collide or hinder the operation of another component of the wheelchair. A check must be performed prior to operation of the chair to ensure all moving pieces move freely and through the entire range of motion without coming into contact with another part of the wheelchair.

5.0 USING THE WHEELCHAIR

DANGER!

1. Be aware that you may need to adjust the controller (joystick) settings of your system.
2. Check and adjust the settings every six to twelve months.
3. Consult your Sunrise Medical authorized dealer to adjust the control settings immediately if you notice any change in your ability to:
 - a. Control the joystick.
 - b. Hold your torso erect.
 - c. Avoid running into objects.

5.1 Checking wheelchair before use

Perform the following daily check routine before driving:

CAUTION!

Checking wheels and tires

Is there still enough tire tread. Are the tires sufficiently inflated. (Chapter 8.2)

Checking batteries

1. Before using your vehicle for the very first time, please charge your batteries for a period of 24 hours.
2. Are the batteries sufficiently charged? The green lights on the battery indicator must be on. ( Controller)

WARNING!

Battery chargers are only intended to charge:

1. 24V
2. Lead Acid and Gel style batteries.

Checking lights and indicators

Ensure that the lights and indicators are functioning correctly and lens screens are clean before going outdoors at night. ( Controller)

Checking remote

With the control system switched off, check that the joystick is not bent or damaged and that it returns to the center when you push and release it.

Checking free wheel switch

Ensure that the free wheel switch has been set to 'drive' / 'engage' (Chapter 5.9).

Checking seating

1. Ensure that all the cushions are in place.
2. Ensure that the backrest is correctly fitted and adjusted.
3. Visually inspect the wheelchair to ensure the leg rests, armrests etc. are correctly positioned and attached to the wheelchair and all fasteners are sufficiently tightened.
4. Ensure that the seat interface knobs are tight and secure.

Checking clothing on potential entrapment

When operating the wheelchair, ensure that your clothing does not hamper the wheelchair (i.e. too long). Before use, always ensure your clothing or accessories do not come into contact with the wheels or other moving and/or rotating parts in which they could become entangled.

Checking weather condition

In winter, batteries have a reduced capacity. During a period of light frost, the capacity is roughly 75% of the normal capacity. At temperatures below 23° F (-5°C) this will be roughly 50%. This will reduce your range of action.

5.2 Making a transfer

Sunrise Medical recommends that you consult your health care provider for assistance in developing your personal front or side transfer technique to best suit your needs and avoid any personal injury.

DANGER!

It is dangerous to transfer on your own. It requires good balance and agility. Be aware that there is a point during every transfer when the seating system seat is not below you.

WARNING!

1. When transferring to and from the wheelchair, do not use the armrest as a means of support.
2. When transferring the user in or out of the seating system never use the footplate as a platform.

For further instructions, warnings, tips and tricks about making a transfer, please refer to ( Seating system).

5.3 Driving the wheelchair

WARNING!

The user of the wheelchair is at all times completely responsible for complying with the applicable local safety regulations and guidelines.

Powered wheelchairs are driven by means of a controller (joystick). There is a separate user manual for the controller and this was included with this wheelchair ( Controller).

1. Switch on the controller.
2. Set the maximum speed limit.
3. Move the joystick in the direction in which you would like to go.
4. Moving the joystick even further forward will cause the wheelchair to drive faster.

Rear view mirror

WARNING!

1. To avoid injury to people around you please be aware that the mirror protrudes outside the space envelope of the chair and could cause injury to someone when driving past.
2. Always ensure that when using the mirror that it is clean and unbroken so that it does not impair your visibility.

Road use

Please show the utmost consideration for the other traffic on the road.

DANGER!

1. Remember that the last thing a car or truck driver expects to see is a wheelchair backing off the curb into the road.
2. If in any doubt, do not risk crossing the road until you are certain that it is safe.
3. Always cross the road as quickly as possible; there may be other traffic.
4. Do not drive over anything that could cause punctures in the tires.
5. Ensure that there are no objects in your path that could possibly become lodged in your chair mechanism or in the spokes of the rear wheels. This could cause the chair to come to a sudden stop.
6. Riding over drains or grids could cause the wheelchair casters or wheels to become lodged, causing the chair to come to a sudden stop.

Adverse conditions

Please be aware that when driving your wheelchair in adverse conditions, e.g. on wet grass, mud, ice, snow, or other slippery surfaces, you may experience a reduction in the grip and traction of your wheelchair.

DANGER!

1. We recommend you take extra precautions in these conditions, particularly on hills and slopes; your wheelchair could become unstable or skid causing possible injury.
2. When you are using a power wheelchair take extra care with loose or long items of clothing. Moving parts, such as wheels, can be potentially dangerous or even fatal if clothing becomes entangled.

NOTE : Extreme variances in temperature may trigger the self protect mechanism in the control system. If this occurs the control system will temporarily shut down to prevent damage to the electronics or the wheelchair.

5.4 Curves

DANGER!

Full speed turns should not be attempted. If you need to turn sharply you must reduce your speed with the joystick or speed setting. This is particularly important when traveling across or down a slope. Disregarding this advice could lead to your wheelchair tipping over.

WARNING!

Use indicators when changing direction (if equipped).

5.5 Breaking and Emergency stop

There are three ways to stop your wheelchair:

1. Simplest and safest way to stop the wheelchair is to release the joystick. This will bring the chair to a halt in a controlled manner.
2. Pulling back the joystick will brake the chair abruptly with a fast stop.
3. Switching the control system off while the chair is in motion will also bring the chair to a halt.

WARNING!

1. Switching the control system off is only to be used in an emergency situation as the stopping action is very abrupt.
2. Never try to stop or slow the seating system with the wheel locks (if applicable). Wheel locks are designed to prevent the system from moving when stopped. They are not brakes.

5.6 Driving on a slope

Your wheelchair has been designed and tested to allow its use on slopes or gradients in standard configuration:

- 7.5° for 5mph and 6mph
- 9° for 8mph

However, you have the option of adjusting your position with the standing option, powered center mount leg rest, or a combination of these options.

DANGER!

1. Elevating, tilting, and leg rest adjustments can affect the wheelchair center of gravity. Under certain conditions this might cause instability that could lead to unintentional tipping. It may be necessary to carry out a risk assessment if the wheelchair is adjusted to extremes.
2. Stopping distances on slopes can be significantly longer than on level ground.

DANGER!

1. In certain circumstances your wheelchair could become unstable.
2. Before attempting to climb or descend a slope or a curb, caution should be taken when using weight shift options (e.g. powered or recline) of the seat and/or your body for a counter balance weight.
3. To improve stability lean forward when driving uphill, with the seat and back in an upright position.
4. Alternatively sit in an upright position when travelling in a forward, downhill direction and/or recline the seat backwards.
5. We strongly recommend that you return the seat and back to their home positions before attempting to climb or descend a slope. Failure to do this may cause the wheelchair to become unstable.
6. If you are in any doubt about the capabilities of your wheelchair on a slope then do not attempt to drive up or down the slope/curb; try to find an alternative route.

Gradients: ascents

WARNING!

1. When going uphill, keep the chair moving.
2. Steer by carefully moving the joystick forward making slight Left and Right adjustments as you go.
3. If you have stopped on a hill, you should start slowly.
4. If necessary lean forward.

Gradients: descents

On descents, it is important not to let the wheelchair accelerate beyond its normal level of ground speed.

DANGER!

1. Proceed slowly down steep descents, (below the speed of 3mph/5kph) and stop if you feel anxious.
2. If the chair picks up speed, center the joystick to its home position to allow it to slow, or to stop.
3. Restart slowly and do not allow the speed to increase above what you are comfortable with.

NOTE: The solid state controller (joystick) has the benefit of a logic system that will help compensate when driving along a camber or up a hill. This is an added safety feature on your wheelchair. In addition of course, you may control the wheelchair speed by using the speed control.

5.7 When seated and driving in lift mode

DANGER!

Your chair may be configured with a Power Seat Lift. Before operating your chair in Lift mode, read all warnings and guidelines related to this feature. They will help in understanding how to reduce the risk of a fall or tip-over and how to identify environmental conditions that could affect your safety when driving while the seat lift is operated.

1. When driving indoors, or outdoors, the lift mode should only be used on flat, level, and hardscape surfaces.
2. Driving in lift mode should never be attempted outdoors on uneven terrain like: gravel, grass, bumpy surfaces, uneven sidewalks, or hills.
3. This feature may be equipped with a system that allows the power chair to drive up to 3 mph when the seat is elevated: this feature is called C-Me.
4. NEVER raise the seat when the chair is being operated in the proximity of any of the terrain types listed above, or on any uneven surface.

NEVER exceed the weight limit of this feature

- 300 lbs (136 kg) for C-Me with speeds up to 3 mph (5 kph)

5.0 USING THE WHEELCHAIR

5.8 Obstacles and curbs

⚠ DANGER!

1. Never descend a curb backwards.
2. Do not attempt to climb or descend a series of steps or use on escalators. It is unsafe to do so and could cause personal injury or damage the chair. This wheelchair has only been designed to climb a single step or curb.
3. We recommend that users with upper trunk instability wear further personalized restraint systems to keep the upright body position during descending or ascending ramps, curbs, or obstacles.

Curb climbing

Always approach a curb at 90° (Fig. 5.1).

1. Approach the curb or step, head on at a 90° angle.
2. Drive forward slowly and steadily.
3. Stop the chair as soon as the caster wheels touch the curb.
4. Apply sufficient power to the motors to lift the front of the chair up onto the curb or step and then apply slightly more power until the drive wheels climb the curb or step smoothly.
5. As far as possible, keep the joystick in the straight forward position.

The maximum obstacle or curb climbing height is 2.4-in (60 mm) for Group 3 and 3-in (75 mm) for Group 4.

The approach speed and process can vary depending on your wheelchair drive type and caster wheel choice.

Descending the curb

⚠ DANGER!

Move the chair slowly and carefully in a forward direction until both front wheels are on the edge of the curb, again in a 90° position to the curb (Fig. 5.1).

Drive as slowly as possible off the curb with the drive wheels. Don't stop the chair during descent of the curb. You will feel more secure if you can lean backwards, but if you can't, don't worry, the wheelchair is extremely stable. As long as you stay within its limitation, you will be quite safe.

The rear of the chair will naturally follow down the curb as you continue to drive slowly forward.

All powered seating options need to be in home position. Your powered leg rests may need to be adjusted to give enough clearance to climb or descend the curb.

We recommend to use the lap belt to feel more secure during descending the curb. For extra protection we recommend to fit every chair with leg rests.

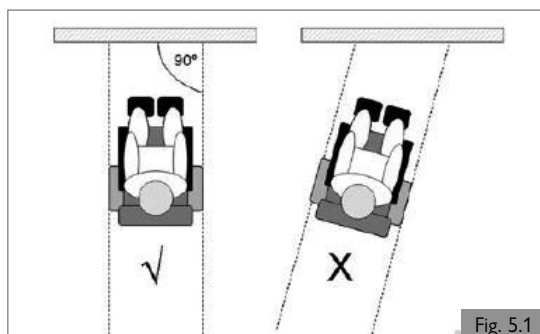

Fig. 5.1

5.9 Pushing the wheelchair

The wheelchair can be moved by pushing. In order to do so, the motors must be disengaged using a freewheel switch. This feature was developed for the attendants of wheelchair users and also functions as an emergency freewheel switch.

The freewheel switch has 2 positions

1. For driving the wheelchair (Fig. 5.2).
'Drive' position: While the chair is off, turn the switch so that the lever at the drive wheel side is pointing upwards.
2. For disengaging the motors (Fig. 5.3 and Fig.5.4).
'Push' position: While the chair is off, turn the switch so that the lever at the drive wheel side is pointing horizontally.

⚠ DANGER!

1. The free wheel switch should only be operated by the attendant and never by the user.
2. A user may never be left unattended while the wheelchair is in 'push'.
3. Never set the switch to the 'push' position on a slope! When the freewheel switch is set to 'push', the automatic parking brake is deactivated. This makes it possible for the wheelchair to roll down the slope.
4. The automatic parking brake only works if the switch is set to 'drive' position.
5. When the wheelchair is no longer being pushed, the freewheel switch should be set to 'drive' immediately.
6. To manually push the system you must release the motor brakes.
7. Do not engage or disengage motor brakes unless power to the system is off.
8. Ensure you have full control over the system when you release the motor brakes. When you do so, the system will not have brakes.
9. Ensure the system is on level ground before you release the motor brakes.
10. Propel this system by the push handles only. They provide secure points for you to hold the rear of the system to prevent a fall or tip-over.
11. Check to ensure push handle grips will not rotate or slip off.

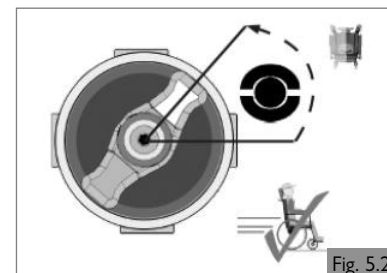

Fig. 5.2

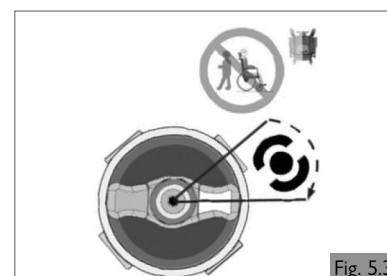

Fig. 5.3

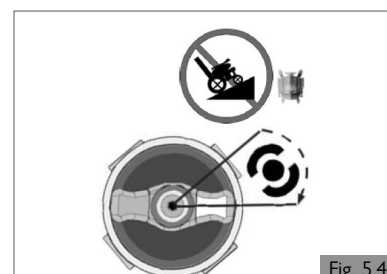



Fig. 5.4

5.10 (Powered) seating options

The wheelchair can be equipped by the following mechanical and/or powered options to adjust your seating position. These options can be operated by the user without the use of tools.

Powered adjustable seating options (Fig. 5.5 - Fig.5.7)

How to operate these powered seating options can be found in

Controller +  Seating:

1. Powered tilt function
2. Powered seat lift
3. Powered backrest recline
4. Powered elevating leg rests

DANGER!

1. Use of the powered adjustable seating options may influence the stability of the wheelchair.
2. Only use the powered adjustable seating options when the wheelchair is on a flat surface! Do Not attempt to operate any power seating option while positioned on an incline.
3. Please stay clear of any powered actuator while the component is in motion. Sunrise power mechanisms move over large ranges of travel. Users should be aware of their surroundings while components are in motion.
4. While driving this seating system in the reclined, elevated, or tilted position use caution.
5. Do Not attempt to operate any power seating option while this seating system is in motion.
6. Do not attempt to operate the lift or tilt power seating options around children.
7. Through programming it is possible to reverse the direction of all powered seating functions; ensure you know which direction your seat is going to move before operating.
8. Please be aware that the lift/tilt modules present a trap hazard. Ensure that during operation the lift/tilt modules are free from all clothing, hands, feet, and other extremities, to prevent injury.
9. Do not drive on ramps or slopes with the seating in the elevated position. Before attempting to climb or descend a slope, return the wheelchair to a standard seated drive position, with the backrest upright.
10. This power system is designed to automatically reduce the maximum driving speed to a creep and/or C-Me mode when certain power seating limits are reached. Depending on the configuration of the chair there might be multiple creep and/or C-Me speeds.
11. Before operating your chair in creep and/or C-Me mode, read all warnings and guidelines related to this feature. They will help in understanding how to reduce the risk of a fall or tip-over and how to identify environmental conditions that could affect your safety when driving while the chair is in creep and/or C-Me speed.
 - a. When driving indoors or outdoors, in creep mode, it should only be used on flat, level, and hardscape surfaces.
 - b. Driving in creep mode should never be attempted on uneven terrain like: gravel, grass, bumpy surfaces, uneven sidewalks, or hills.
 - c. This feature may be equipped with a system that allows the power chair to drive up to 3 mph when the seat is elevated; this feature is called C-Me.
 - d. NEVER raise the seat when the chair is being operated in the proximity of any of the terrain types listed above, or on any uneven surface.

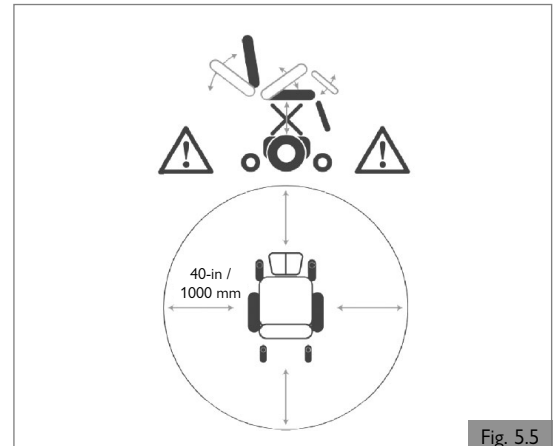

Fig. 5.5



Fig. 5.6

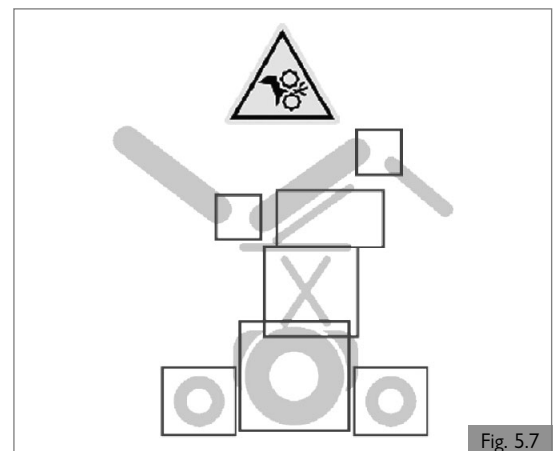

Fig. 5.7

6.0 BATTERIES, CHARGING, AND RANGE

6.1 Batteries

Batteries are the power source for almost all of the modern mobility products available today. The design of batteries used in mobility products is significantly different to the batteries used to start a car for example. Car batteries are designed to release a large amount of power over a short period of time, while mobility batteries (commonly called deep cycle batteries) release their power evenly, over a long period of time. Therefore, due to the lower production volumes and increased technological requirements, mobility batteries are typically more expensive.

Commonly two 12 volt batteries are used together in a mobility product, giving a total voltage of 24 volts. The size of the battery (e.g. its available power) is expressed in amps per hour e.g. 70amp/hr. The higher the number, the bigger the battery size, weight and, potentially, the greater the distance you can travel. Sunrise Medical only fit as standard maintenance free batteries into these types of wheelchairs. This type of battery uses a method of carrying the electrolyte commonly referred to as 'gel', that is held within the battery case. As the name implies, no maintenance is required other than regular charging. You can safely transport this type of battery without fear of acid spilling. Furthermore, they are approved for transportation on aircraft, trains, and ships.

⚠ CAUTION!

1. Do not fit car batteries to the wheelchair. Fit only deep cycle, maintenance free mobility batteries.
2. When the batteries are worn out, take them to the local authority disposal point.
3. Return the batteries directly to the battery manufacturer for recycling, when they no longer hold a charge.
4. The battery terminals need to be checked regularly for signs of corrosion. If any corrosion is apparent, clean the terminals completely and apply petroleum jelly or silicone grease to the terminal. Do not use ordinary grease. Ensure that the terminal nut and bolt, cable clip, and exposed cable are completely covered with petroleum jelly or silicone grease.

⚠ DANGER!

1. Do not expose any part of the battery to direct heat (i.e. naked flame, gas fire).
2. Be extra cautious to reduce the risk of dropping a metal tool onto the battery. It could spark or short circuit the battery or other electrical parts that may cause an explosion. Also take off all personal metal effects and dangling objects when working on the battery.

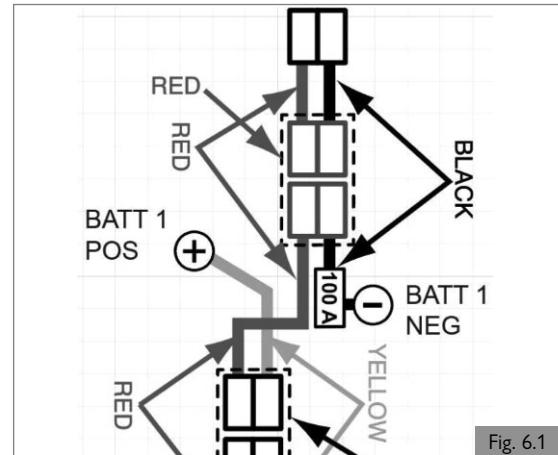

⚠ DANGER!

1. Do not, under any circumstances, tamper with the batteries. If in any doubt contact your Sunrise Medical authorized dealer.
2. Avoid contact with acid on damaged sealed type batteries or wet batteries.
3. Battery acid can cause burns to the skin as well as damage to floors, furniture, and your wheelchair.
4. If battery acid comes into contact with the skin or clothing, wash immediately with soap and water.
5. If battery acid comes into contact with the eye, immediately flood the eye with running cold water for at least 10 minutes and seek medical attention immediately.
6. Acid spills can be neutralized with baking soda and water.
7. Ensure you keep batteries upright at all times, especially when transporting your wheelchair.

Safety cut-outs

In the event of a short circuit there are several safety systems built into your wheelchair to safeguard your electrical circuits (Fig. 6.1).

1. Fusible 100A links are connected into the battery harnesses to protect the batteries and wiring.
2. 15A auxiliary power circuit fuses for auxiliary modules.

To replace them contact your Sunrise Medical authorized dealer, who will also diagnose the original fault.

6.2 Charging batteries

 Battery charger: Please read the user manual supplied with the charger carefully. The general procedures and effects for the interference with the chair and the batteries remain valid.



Battery care plan

Below is set out a battery care plan for maintenance free batteries. This has been agreed between Sunrise Medical and the battery manufacturers, to enable you to get the best out of your batteries. If a different care plan is followed, this may result in lower than expected performance from your mobility vehicle.

1. Only use an approved Sunrise Medical charger compatible with the vehicle to be charged.
2. Charge your batteries every night, regardless of the amount of use your mobility device has had during the day.
3. Do not interrupt the charging cycle.
4. If your mobility device is not required for use, it should remain connected to the charger until required. This will not damage your batteries, as long as the main socket/plug is left switched on. Turning the main socket/plug off, but leaving the main cable plugged in, will eventually deplete your battery charge.
5. If you leave your vehicle for an extended period (in excess of one week) charge the batteries fully and then disconnect the main battery lead.
6. Failure to allow for recharge will damage the batteries and can lead to shorter distances and premature failure.
7. Do not top up the charge of your batteries during the day. Wait until the evening for a full overnight charge.
8. As a general rule, maintenance free batteries take longer to fully charge than "wet" lead acid batteries.
9. The battery terminals need to be checked regularly for signs of corrosion. If any corrosion is apparent, clean the terminals completely and apply petroleum jelly or silicone grease to the terminals. Do not use ordinary grease. Ensure that the terminal nut and bolt, cable clip, and exposed cable are completely covered with petroleum jelly or silicone grease.
10. Following all the points above should result in a healthier battery, greater range for the vehicle user, and a longer life for your batteries.

Connecting the battery charger

Procedure for connecting the charger and charging:

1. Switch off the wheelchair controller. ( Controller)
2. Connect the battery charger round output plug to the charging socket on the front of the joystick module. ( Controller)
3. Connect the charger to the main supply by means of the main plug and switch on.

For more information about the charger operation, consult the instructions provided with the charger. ( Battery Charger)
Depending on how depleted the batteries are, it may take up to 12 hours to fully charge the batteries again.

DANGER!

1. Ensure the cord is located so that it will not be stepped on, tripped over, or otherwise subjected to damage or stress.
2. Do not rest a battery on top of the charger.
3. Do not stand the charger on a carpet or other soft surface. Always place it on a hard, flat surface.
4. Do not operate the charger if it has received a sharp blow, been dropped, or otherwise damaged in any way. Take it to a Sunrise Medical authorized dealer.
5. Never place the charger directly above the battery being charged; gases from the battery will corrode and damage the charger.
6. Never charge a frozen battery. A fully charged battery will rarely freeze but the electrolyte of a discharged battery can freeze at 16°F (-9°C). Any battery that is suspected of being frozen should be thawed completely before charging.

7. Never sit with the charger on your lap when charging your batteries.
8. The charger casing will get hot during its normal operation.
9. Do not disassemble charger; only have it repaired by the manufacturers. Incorrect re-assembly may result in a risk of electric shock or fire.
10. To reduce the risk of an electric shock, unplug the charger from the outlet before attempting any maintenance or cleaning. Turning off the controls will not reduce the risk.
11. Never smoke or allow a spark or flame in the vicinity of battery or charger.
12. You should not charge your batteries in outdoor conditions.
13. It is advised to use a smoke detector in the charging area.

Battery Charger

The external charger has been designed to charge two 12V Gel type batteries connected in series (= 24 V).

The chargers have features which prevent hazards or accidents occurring as a result of connecting batteries the wrong way round, overheating caused by fault conditions or attempting to charge wrong voltage batteries.

The majority of charger sizes are electrically double insulated and no earth connection is required. Some larger sizes may be electrically earthed and this will be clearly stated on the label.

WARNING!

Battery chargers are only intended to charge 24V; Lead Acid or Gel style batteries.

DANGER!

1. As with all main powered electrical equipment, always replace blown fuses with the same type and size of fuse as specified.
2. Fitting of different fuses can result in an increased fire risk, damage to the charger, or failure of the charger to operate properly.

6.3 The range of your vehicle

Please refer to the specification tables at the back of this manual for Energy Consumption (Maximum Range information).

Most manufacturers of mobility products state the range of their vehicles either in the sales literature or within the User Manual. The range stated sometimes differs from manufacturer to manufacturer even though the battery size is the same. Sunrise Medical measures the range of their vehicles in a consistent and uniform manner, but variances still occur due to motor efficiencies and overall product load weight.

The range figures are calculated to ISO 7176-4:2008. Part 4: Wheelchair Energy Consumption Theoretical Range.

This test is carried out in controlled conditions with new, fully charged batteries, on a level test surface and a user weight of 220 lbs (100 kg). The range figures stated should be seen as a theoretical maximum and could be reduced if any single, or combination, of the following circumstances occur:

1. User weight heavier than 220 lbs (100 kg)
2. Batteries whose age and condition are less than perfect.
3. The terrain is difficult e.g. very hilly, sloping, muddy ground, gravel, grass, snow, and ice.
4. The vehicle climbs curbs regularly.
5. The ambient temperature is very hot or very cold.
6. Incorrect tire pressures in one or more tires.
7. Lots of start/stop driving.
8. Also thick pile carpets within the home can affect range.
9. Use of additional power consumption options (e.g. light, actuators, etc.).

The battery sizes available on each Sunrise Medical product should give sufficient range to cope with the majority of customer's lifestyles.

6.0 BATTERIES, CHARGING, AND RANGE

6.4 Replacing batteries

The wheelchair uses two 12V non-spillable 'dry' gel batteries in series. These batteries are fully sealed and require no maintenance.

Replacing and servicing batteries is to be done by a Sunrise Medical authorized dealer.

In case of malfunctioning batteries, contact your Sunrise Medical authorized dealer.

⚠ DANGER!

Do not attempt to replace or service batteries without the supervision of trained and qualified personnel.

6.5 Disconnecting batteries for air transport

The batteries are contained within the drive unit located under the battery shroud.

Note: Steps in this procedure may require two people to perform.

To disconnect the batteries:

1. Release the two handle screws under the front of the seat frame, that connect the seat frame with the seat module interface (Fig.6.2).
2. Carefully flip the seat frame backwards (Fig.6.3) until the seat frame is in the fully opened position.
3. Lift off the base shroud (B) (Fig. 6.4).
4. Insert red seat stay pin into the hole located in the seat module interface (Fig. 6.4)
5. Disconnect the 2 pin Anderson connectors from each battery (Fig.6.5).
6. To reconnect the batteries reverse the above procedure.
7. Ensure that the tethers of the two handle screws are secured around the two seat posts.
8. Ensure that all cables are contained within the battery box before replacing the base shroud.
9. When finished carefully guide the seat frame down and replace the two handle screws.

⚠ WARNING!

Removing the batteries can lead to a change of the center point of gravity. The result may be that the chair flips backwards without the weight of the batteries. Sunrise Medical advises to:

1. Put an obstacle behind the chair to secure the situation. This can be a chest, or a chair, or etc.
2. Try to lift the battery slightly first to check the effect of taking out the weight.
3. Only remove the batteries while the chair is on the ground.
4. Do not remove the batteries while the chair is on a lift table or on any other elevated surface.

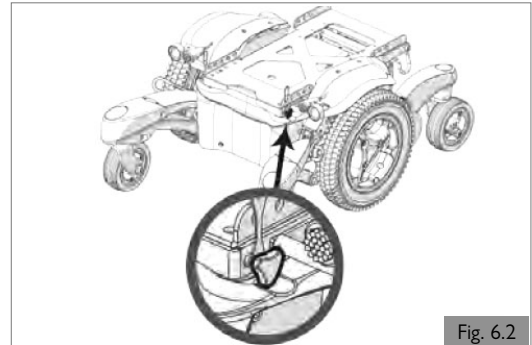

Fig. 6.2



Fig. 6.3

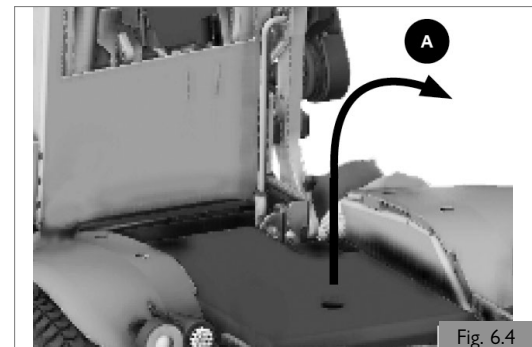

Fig. 6.4



Fig. 6.5

7.1 Transport of the wheelchair in a car

Getting in and out of the vehicle

⚠ DANGER!

1. Confirm that the vehicle is suitably equipped to transport a passenger in a wheelchair, and ensure the method of access/egress is suitable for your wheelchair type. The vehicle should have the floor strength to take the combined weight of the occupant, the wheelchair, and accessories. Use a ramp (or lifting device) suitable for the entire weight of the wheelchair (including user) for entering the vehicle.
2. The wheelchair should be secured in a forward facing direction. This wheelchair is approved for use in cars and meets the requirements for forward facing transport and head on collisions. The wheelchair has not been tested for other positions in a vehicle (Fig. 7.1).

⚠ CAUTION!

1. Sufficient space should be available around the wheelchair to enable clear access to attach, tighten, and release the wheelchair and occupant tie down restraints and safety belts.
2. Ease of access to, and maneuverability in, motor vehicles can be significantly affected by wheelchair size and turning radius; smaller wheelchairs and/or wheelchairs with a shorter turning radius will generally provide greater ease of vehicle access and maneuverability to a forward-facing position.

Securing the wheelchair with a strap restraint system

This wheelchair has been successfully crash tested in accordance to: ISO 7176-19:2008, using a representing restraint system.

Secured with a 4-point strap restraint system (2 in the front, 2 in the back (Fig.7.2), that conforms to:

1. ISO 10542 (international) or
2. SAE J2249 (USA).

NOTE: Wheelchair secured with a 4-point strap restraint system; suitable for the total weight of the wheelchair (including any options) in accordance with the WTORS1 manufacturers' instruction.

Terminology explained:

1) WTORS: *Wheelchair Tie-down Occupant Restraint System*

⚠ DANGER!

1. The wheelchair can only be secured by using the tie-down points on the wheelchair's frame (Fig. 7.2 - 7.5)
2. The tie-down points (2 in the front, 2 in the back) are indicated by the tie-down symbol (Fig. 7.5). Fit the front straps first, then the rear. Tension the straps to secure the wheelchair. The wheelchair may not be secured onto any accessories (armrests, anti-tip brackets, etc.).
3. No changes or replacements must be made to the anchorage points/car fastenings on the wheelchair, or to constructional elements or parts of the frame without consulting the manufacturer.
4. When the wheelchair is transported in a vehicle without occupant and no restraint system is available then the wheelchair should be properly stored and secured in the cargo area during travel.

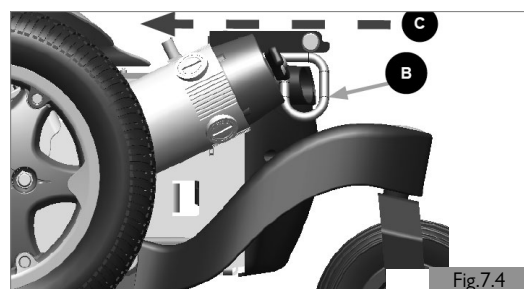
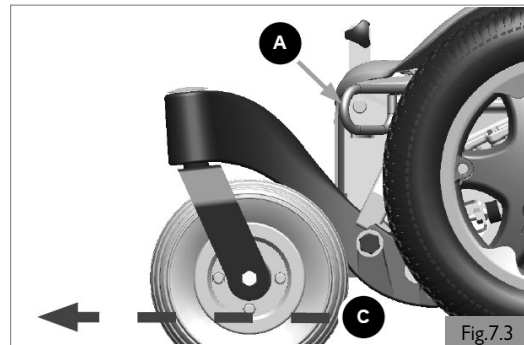
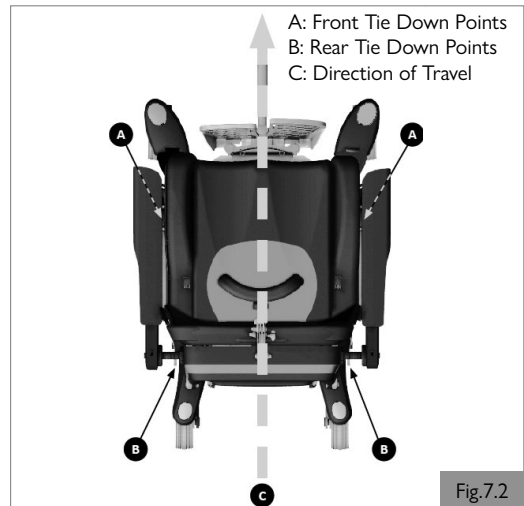
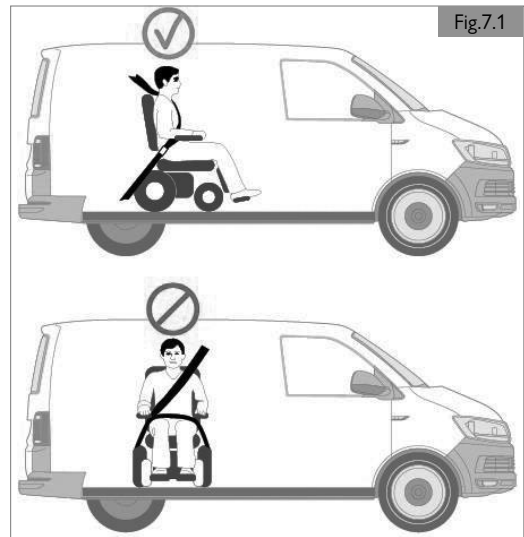

7.0 TRANSPORTATION

7.2 The wheelchair as a passenger seat

A wheelchair secured in a vehicle will not provide the equivalent level of safety and security as a vehicle seating system. Sunrise Medical recommends that the user transfers to the vehicle seating and uses the vehicle-installed restraint system whenever possible. Sunrise Medical recognizes that it is not always practical for the user to be transferred and in these circumstances, where the user must be transported while in the wheelchair, the following advice must be followed:

⚠ DANGER!

1. The safety of the user during transportation depends upon the diligence of the person securing the tie down restraints, and they should have received appropriate instructions and/or training in their use.
2. Wherever possible remove and stow safely away from the wheelchair all auxiliary equipment, e.g. : crutches, loose cushions, tray tables, etc.
 - a. Removed and secured separately in the vehicle, or
 - b. Secured to the wheelchair, but with energy-absorbing padding placed between the table and the user.
3. Articulating/elevating leg rest should not be used in the elevated position when the wheelchair and user are being transported.
4. If applicable: Reclining backrests should be returned to an upright position.
5. If applicable: Seat elevators should be in the lowest position.
6. If applicable: The manual brakes must be firmly applied.
7. Use only with Wheelchair Tie-down and Occupant Restraint Systems (WTORS) that have been installed in accordance with the manufacturer's instructions and SAE J2249.
8. Attach WTORS to securement points (A) (B) in accordance with the manufacturer's instructions and SAE J2249.
9. Attach occupant restraints in accordance with the manufacturer's instructions and SAE J2249.
10. Ensure hip guides are locked in place.
11. Use only Wheelchair Tie-down (A, B) and Occupant Restraint Systems (WTORS) which meet the requirements of SAE J2249 Recommended Practice—Wheelchair Tie-down and Occupant Restraint Systems For Use in Motor Vehicles. Do not use WTORS designed to rely on the wheelchair structure to transfer occupant restraint loads to the vehicle.
12. The wheelchair has been dynamically tested in a forward facing mode for a 30 mph (48 kph) frontal impact test. The wheelchair must be forward facing during transport.
13. Postural supports and positioning devices should not be relied on for occupant restraint.
14. Do not alter or substitute wheelchair frame parts, components, or seating.
15. Sudden stops, impacts, or vehicle collisions can structurally damage your chair. Chairs involved in such incidents should be replaced.

Occupant restraint instruction

⚠ DANGER!

1. Use a 3-point occupant restraint system to secure the occupant.
2. Both pelvic and upper torso restraint belts must be used to restrain the occupant to reduce the possibility of head and chest impacts with the vehicle components.
3. Restraints should be mounted to the appropriate vehicle pillar and should not be held away from the body by wheelchair components such as armrest or wheels (Fig. 7.6).
4. Use a suitable positioned headrest when being transported in a wheelchair.
5. Postural supports (lap straps, lap belts) should not be used or relied on for occupant restraint in a moving vehicle unless they are labeled as meeting the requirements specified in ISO 7176-19:2008 or SAE J2249.

Positioning the occupant restraint

⚠ DANGER!

1. The pelvic restraint belt must be worn low across the front of the pelvis so that the angle of the pelvic belt is within the preferred zone of 30° to 75° to the horizontal.
2. A steeper (greater) angle within the preferred zone is desirable i.e. closer to, but never exceeding 75° degrees (Fig. 7.6).
 - a. The upper torso restraint belt must fit over the shoulder and across the chest as illustrated (Fig. 7.6). Restraint belts must be adjusted as tightly as possible consistent with user comfort. Do not fit restraint belt as shown in Fig. 7.7.
3. Restraint belt webbing must not be twisted when in use.
4. Care should be taken when applying the occupant restraint to position the seatbelt buckle so that the release button will not be contacted by wheelchair components during a crash.

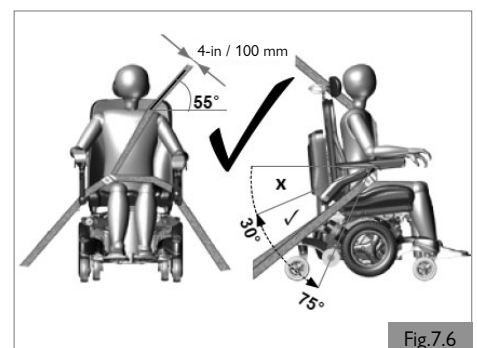

Fig.7.6

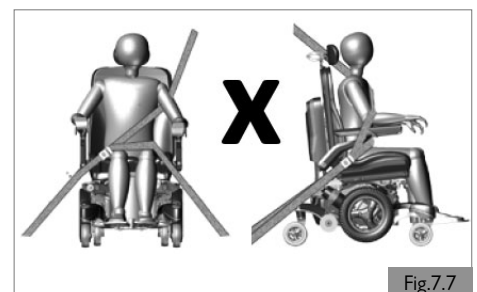

Fig.7.7

7.3 Special transit requirements

Using your wheelchair on the train

Before you travel, please contact the train operator. They will be able to supply details of any special requirements/instructions. We advise you to check the following:







1. Is there a suitable and intended “wheelchair” area in the train for wheelchair users (with adequate turning space to maneuver)?
2. Is there a suitable or designated area on the platform for wheelchair users (with adequate turning space to maneuver)?
3. Is there suitable boarding access available to allow you to access the railway carriage and the intended “wheelchair” area?
4. Is the boarding access suitable for the combined mass of the wheelchair and the occupant?
5. Ensure the slope of the boarding access is not greater than the dynamic safe slope. (See Section 10)
6. Any obstacles or thresholds should not exceed the max curb climbing capability of your wheelchair. (See Section 10)

Most train operators will provide assistance provided that arrangements have been made in advance. We suggest you have your User Manual ready when planning your journey and contact them.

WARNING!

Transporting the wheelchair as luggage

Parts of the wheelchair that can easily be detached should be removed when transporting the wheelchair. Store these parts securely. E.g.:

- a. Remove the seat ( Seating system)
- b. Remove the leg rests ( Seating system)
- c. Remove the armrests ( Seating system)
- d. Fold down the backrest ( Seating system)
1. Ensure that any detachable parts are secured with your mobility aid or separately packed and labeled so they do not get lost during loading and unloading.
2. The wheelchair may be transported by road, rail, sea, or air and the batteries conform to IATA regulations.
3. Before you travel, please contact the appropriate carrier. The travel operator will be able to supply details of any special requirements/instructions.
4. For information about dimensions and weight of the wheelchair see (Section 10).
5. For information about the batteries in your wheelchair see (Section 6).
6. Ensure that any detachable parts are secured with your mobility aid or separately packed and labeled so they do not get lost during loading and unloading.
7. Take this user manual, the seating system user manual ( Seating System) and the controller user manual ( Controller) with you. The carrier will need to refer to the following sections:
 - a. Pushing the wheelchair (Section 5.9).
 - b. How to lock/unlock the controller: ( Controller)
 - c. How to disconnect the batteries (Section 6.5).
 - d. How to disconnect the drive (Section 5.9).
 - e. Transporting the chair (Section 7.0).
 - f. Medium to long term storage, follow the instructions (Section 8.5)

7.4 General transport warnings

WARNING!

1. No changes or replacements must be made to the anchorage points/car fastenings on the wheelchair, or to constructional elements or parts of the frame without consulting Sunrise Medical.
2. The wheelchair should be inspected by a Sunrise Medical authorized dealer, before reuse following involvement in any type of vehicle collision. If damage is questionable or if there is concern regarding the condition of the chair, Sunrise Medical recommends replacement of the chair.

NOTE- The warranty is void on any wheelchair that is involved in a collision.

8.0 MAINTENANCE AND CLEANING

The wheelchair's lifespan is dependent on it being well maintained.

For information concerning specific settings, maintenance, or repair work, please contact your Sunrise Medical authorized dealer. Always ensure you mention the model and year of manufacture and identification number provided on the serial number label of the wheelchair when contacting your Sunrise Medical authorized dealer.

CAUTION!

The wheelchair should be serviced by your Sunrise Medical authorized dealer once a year or, in the case of intensive use, every six months. For a list of approved Sunrise Medical authorized dealers in your area please contact Sunrise Medical Customer Service.

The contact details of your local Sunrise Medical Service Center can be found on the inside front cover of this booklet.

Website address is on the back cover.

8.1 Maintenance

WARNING!

- Loose fasteners should be re-tightened according to the installation instructions. See section 8.1 for specified torque values.
Note: it will be necessary to use a torque wrench.
- Chest straps should be replaced at the first indication of damage and/or excessive wear.
- If a broken or loose component is found, discontinue use immediately and contact your Sunrise Medical authorized dealer for replacement.
- Check all Velcro® fastening straps for correct adhesion when pressed together.
- Ensure that any contamination, such as fluff, hair, etc. is removed from the Velcro® straps. Such contamination may affect adhesion.

WARNING!

- If you are in any doubt about the performance requirements of your wheelchair contact your Sunrise Medical authorized dealer.
- After performing any maintenance or repairs on the wheelchair you must ensure that it is functioning correctly before it is used.
- All fasteners must be replaced like for like using the correct length, tensile strength, and materials.
- When replacing self-locking nuts, or nuts/studs secured with a thread locking solution, ensure that a suitable thread locking solution is reapplied to the fastener.

Daily checks

Perform the daily check routine before driving as described in section 5.1.

Weekly checks

Perform the weekly check routine before driving as described below.

Checking Parking brake

This test should be carried out on a level floor with at least 39-in (1 meter) clearance all around the chair.

- Switch on the control system.
- Check that the battery gauge remains on, or flashes slowly, after one second.
- Push the joystick slowly forward until you hear the parking brakes operate.
- The chair may start to move.
- Immediately release the joystick. You must be able to hear each parking brake operate (click) within a few seconds.
- Repeat the test a further 3 times, pushing the joystick slowly backward, left and right.

Checking connectors and cables

- Ensure that all connectors are securely mated.
- Check the condition of all cables and connectors for damage.

Checking controller

- Check the thin rubber gaiter or boot around the base of the joystick shaft for damage or splitting. Check visually only; do not handle the gaiter.
- Ensure that all components of the control system are securely mounted. Do not over-tighten any securing screws.

Checking controls

- Switch on the hand control – Do the lights flash? This signifies that there is a fault in the electronic system. Refer to section 9 for basic troubleshooting.
- Operate all of the electric options, including lights and indicators (if fitted) to ensure that they work correctly.
- With the seating in an elevated position, drive the wheelchair to ensure that the reduced speed mode works which will slow the wheelchair.
- Drive the wheelchair in each of the drive profiles to ensure the wheelchair performs as it did before.

General weekly checks

- Check tires for proper inflation level (if applicable).
- Check frame and base for foreign objects and/or obstructions.
- Ensure the knobs that attach the seat frame to the front of the base are not loose.

Quarterly checks

Perform the quarterly check routine before driving as described below.

- Check all straps for fraying, ripped seams, or other indications of excessive wear damage. Discontinue use if damage is found and contact a Sunrise Medical authorized dealer.
- Check chair for any missing or loose nuts, bolts, and/or fasteners. Contact a Sunrise Medical authorized dealer if found.
- Check wheelchair for any broken components, unusual wear, or other indicators of excessive wear. Discontinue use if damage is found and contact a Sunrise Medical authorized dealer.

WARNING!

- If you are in any doubt about the performance requirements of your wheelchair contact your Sunrise Medical authorized dealer.
- After performing any maintenance or repairs on the wheelchair you must ensure that it is functioning correctly before it is used.
- A complete inspection, safety check, and service should be made by a Sunrise Medical authorized dealer at least once per year.
- All fasteners must be replaced like for like using the correct length, tensile strength, and materials.
- When replacing self-locking nuts, or nuts/studs secured with a thread locking solution, ensure that a suitable thread locking solution is reapplied to the fastener.
- Check all Velcro® fastening straps for correct adhesion when pressed together.
- Ensure that any contamination, such as fluff, hair, etc. is removed from the Velcro® straps. Such contamination may affect adhesion.
- Do not reuse fasteners.

To be performed by:

Maintenance and Inspection Schedule	End User / Caregiver			Sunrise Medical Authorized Dealer
	Daily*	Weekly*	Quarterly*	Annually
Daily Check routine as described in Section 5.1	<input checked="" type="checkbox"/>			
Weekly Check routine as described in Section 8.1		<input checked="" type="checkbox"/>		
Clean wheelchair upholstery ( Seating system)		<input checked="" type="checkbox"/>		
Quarterly Check routine as described in Section 8.1			<input checked="" type="checkbox"/>	
Complete inspection, safety check, and service should be made by a Sunrise Medical authorized dealer				<input checked="" type="checkbox"/>

* Daily = Before each use of the wheelchair. Quarterly = Every three (3) months.

If fasteners are found to be loose a Sunrise Medical authorized dealer should tighten the fastener to the torque setting per size detailed below, unless stated otherwise in all appropriate owner's manuals or instruction sheets (if applicable).

- M8 Fasteners = 13.5-14.9 Nm (120-132 in-lbs)
- M6 Fasteners = 6.8-7.9 Nm (60-70 in-lbs)
- M5 Fasteners = 3.1-3.6 Nm (27-32 in-lbs)
- M4 Fasteners = 0.7-0.9 Nm (6-8 in-lbs)

8.2 Wheels and tires maintenance

To ensure that your wheelchair functions properly, it is essential that the tires are kept at the correct pressure. The correct tire pressure is indicated on the side of the tire.

Tires that are too soft will have a negative effect on the wheelchair's performance. Moving the wheelchair will require more energy, making more demands on the batteries. Furthermore, wear on under inflated tires is increased.

When inspecting the tires for signs of wear, look for significant scuff marks, cuts, and a diminished tire tread. Tires will need to be changed when the tread cannot be seen over the complete surface of the tire.

Caster Wheel	Maximum tire pressure	
6-in	Solid wheels	
Drive Wheel	Maximum tire pressure	
14-in	3.5 bar maximum	50 PSI maximum

DANGER!

1. Do not inflate beyond the maximum allowed tire pressure.
2. Always use the pump that is supplied with the chair.
3. Never use a gas station pump.
4. Before tires are repaired they must first be fully deflated!

8.0 MAINTENANCE AND CLEANING

8.3 Lighting maintenance

DANGER!

Maintaining lights and indicators is a safety critical task. If your lights and indicator system shows a defect, please contact your Sunrise Medical authorized dealer.

All lights and indicators are state of the art LED low energy, no maintenance units. There are no light bulbs used. The high intrinsic reliability of these units means that they are extremely unlikely to fail under normal usage. If a failure should occur (may be as a result of an impact) the damaged light assembly must be replaced in its entirety. The individual LED's cannot be replaced.

CAUTION!

1. We recommend the use of Sunrise Medical authorized spare parts only.
2. Be advised that all lighting circuits are electronically protected. In the event of a short circuit, current will be limited to a safe level. Once the fault is removed the system resets automatically.

8.4 Cleaning and disinfection

The wheelchair should be wiped down once per week with a slightly damp, not wet, cloth and any fluff or dust that has accumulated around the motors should be blown or dusted away.

CAUTION!

Ensure that you dry all parts of your wheelchair if it becomes wet or damp after cleaning or if it is used in a wet or damp environment.

DANGER!

It is important that should the wheelchair be used by more than one person it is cleaned thoroughly to ensure there is no cross infection.

Hygiene measures when being re-used

Prior to the wheelchair being re-used, it must be carefully prepared. All surfaces which come into contact with the user must be treated with a disinfection spray.

To do this, you must use a suitable disinfectant for rapid alcohol-based disinfection of medical products and medical devices.

Please take into account the manufacturer's instructions for the disinfectant you are using.

CAUTION!

1. Do not use solvents, bleaches, abrasives, synthetic detergents, wax polishes, or aerosols.
2. Disinfectants may be used in dilution as specified by the manufacturer.
3. Ensure surfaces are rinsed with clean water and dried thoroughly.

WARNING!

1. Always read the label on any commercial or domestic cleaning substances.
2. Always follow the instructions carefully.

Cleaning controls (Controller)

Should the control of your wheelchair become soiled or dirty, it can be wiped with a damp cloth with a dilute disinfectant until clean.

8.5 Medium to long term storage

When storing your wheelchair for long periods of time (in excess of one week), follow these simple instructions:

1. Fully charge the wheelchair for at least 24 hours.
2. Disconnect the charger.
3. Disconnect the batteries.

WARNING!

Never store your wheelchair:

1. Outside.
2. In direct sunlight (plastic parts may discolor).
3. Near a source of direct heat.
4. In a damp environment.
5. In a cold environment.
6. With the batteries/battery boxes connected (even if the controller is switched off).

Avoiding all of the above will minimize battery deep cycle discharge and extend battery lifetime.

When returning the wheelchair to use, please reconnect the batteries/battery boxes and charge the wheelchair for at least 24 hours before use.

9.0 TROUBLE SHOOTING

If the wheelchair is not working as it should, check the following points:

1. Check whether the batteries are charged.
2. Turn the wheelchair off and then back on again.
3. Check whether the battery plugs are all securely in place.
4. Check whether the freewheel switch is in the DRIVE position.
5. Check the position of the speed regulator.
6. Ensure that the controller isn't locked. ( Controller)

If the problem has not been resolved:

Consult the trouble shooting section for the controller. ( Controller)

10.0 TECHNICAL SPECIFICATIONS: APPLICABLE NORMS / STANDARDS



This product complies with the regulations and guidelines for medical aids and carries a CE symbol.

The product meets the requirements and standards below. These are checked by independent institutions.

Standard	Definition / Description	Maximum User Weight
EU guideline 93/42 EEC	Applicable as mentioned in Appendix 1	N/A
NEN-EN 12182:2014 Class B	“The requirements from EN12182 as mentioned in NEN-EN 12184: Assistive products for persons with disability - General requirements and test methods”	450 lbs / 204 kg
NEN-EN 12184:2014 Class B	Electrically powered wheelchairs, scooters and their chargers - Requirements and test methods	450 lbs / 204 kg
ISO 7176-8:2014	Requirements and test methods for impact, static, and fatigue strengths	N/A
ISO 7176-9:2009	Climate tests for electric wheelchairs	N/A
ISO 7176-14:2008	Requirements and test methods for control systems for electric wheelchairs	N/A
ISO 7176-16:2012	Requirements for resistance to ignition of upholstered parts	N/A
ISO 7176-19:2008	Wheelchairs - Part 19: Wheeled mobility devices for use as seats in motor vehicles: The Q-series meet the crash test requirements as described in ISO 7176-19	450 lbs / 204 kg
ISO 7176-4:2008	Wheelchair Energy Consumption Theoretical Range	450 lbs / 204 kg
ANSI/RESNA WC-1:2009	Requirements and test methods for wheelchairs (including scooters)	N/A

11.0 SUNRISE LIMITED WARRANTY

THIS GUARANTEE DOES NOT AFFECT YOUR LEGAL RIGHTS IN ANY WAY.

Sunrise Medical* provides a guarantee, as set out in the warranty conditions, for wheelchairs to its customers covering the following.

Warranty conditions

1. **FOR FIVE (5) YEARS** - Sunrise warrants the frame of this wheelchair against defects in materials and workmanship for five years from date of first consumer purchase.
2. **FOR ONE (1) YEAR** - We warrant all Sunrise-made parts and components of this wheelchair including: motors, gearboxes, and electronic components, against defects in materials and workmanship for one year from the date of first consumer purchase.
3. **BATTERIES** - The batteries are covered by a one (1) year warranty provided through the original battery manufacturers.
4. **LIMITATIONS**
 1. We do not warrant:
 - a. Tires and tubes, upholstery, pads, and push-handle grips.
 - b. Damage from neglect, accident, misuse, or from improper installation or repair.
 - c. Products modified without Sunrise Medical's express written consent.
 - d. Damage from exceeding the weight limit.
 2. This warranty is VOID if the original chair serial number tag is removed or altered.
 3. This warranty applies in the USA and Canada only. Check with your Sunrise Medical authorized dealer to find out if international warranties apply.
 4. This warranty is not transferable and only applies to the first consumer purchase of this wheelchair through a Sunrise Medical authorized dealer.
5. **WHAT WE WILL DO** - Our sole liability is to repair or replace covered parts. This is the exclusive remedy for consequential damages.
6. **WHAT AUTHORIZED DEALER MUST DO** -
 1. Obtain from Sunrise Medical, while this warranty is in effect, prior approval for return or repair of covered parts. Contact Customer Service for a Returned Material Authorization (RMA) number and information as to where to return the product. Upon contacting Customer Service please provide Model number, Serial number, description of what is required for service/repair, and any additional information as to reason for service being performed to the wheelchair.

7. NOTICE TO CONSUMER -

1. You must pay the cost of labor to repair, remove, or install parts even if they are covered under warranty.
2. If allowed by law, this warranty is in place of any other warranty (written or oral, express or implied, including a warranty of merchantability, or fitness for a particular purpose).
3. This warranty gives you certain legal rights. You may also have other rights that vary from state to state or province to province.
8. This guarantee is subject to the law of the country in which the product was purchased from Sunrise Medical.

* Denotes the Sunrise Medical facility from which the product was purchased.

ADDITIONAL WARRANTY INFORMATION FOR AUSTRALIA ONLY

1. For goods provided by Sunrise Medical Pty Ltd in Australia, our goods come with a guarantee by Sunrise Medical that cannot be excluded under the Australian Consumer Law.
2. You are entitled to a replacement or refund for a major failure and for compensation for any other reasonably foreseeable loss or damage.
3. You are also entitled to have the goods repaired or replaced if the goods fail to be of acceptable quality and the failure does not amount to a major failure.
4. The benefits to you given by this warranty are in addition to your other rights and remedies under a law in relation to the goods to which the warranty relates.

Record your serial number here for future reference:

(located on right side of the base on the top front of the battery box)

www.SunriseMedical.com



Customer Service:
800.333.4000
In Canada 800.263.3390

Sunrise Medical
2842 Business Park Ave.
Fresno, CA 93727 • USA

©2021 Sunrise Medical (US) LLC
10.2021 P/N 247553 Rev. I